



VELUX®

Skylights

2025 Price List

Residential Skylights and Sun Tunnel® Skylights

Effective April 7, 2025

All retail prices are not valid in Alaska, Hawaii, or Mexico due to additional freight cost.

Contents

8	Unit Skylight Systems	
	VSS/VSE Deck-Mounted Solar/Electric Venting	8
	VCS/VCE Curb-Mounted Solar/Electric Venting	10
	VS Deck-Mounted Manual Venting	12
	VCM Curb-Mounted Manual Venting	14
	FS Deck-Mounted Fixed	16
	QPF Self-Flashed Fixed	18
	FCM Curb-Mounted Fixed	20
22	Custom Size Skylights	
	FCM Curb-Mounted Fixed In Stock Custom Sizes	22
	FCM Curb-Mounted Fixed Custom Sizes	24
	EVMS/EV Self-Flashed Venting	26
	EF Self-Flashed Fixed	28
	GSM Curb-Mounted Fixed SkyMax	30
32	Sun Tunnel® Skylights	
	Rigid/Flex Tube	32
	Wildfire/Impact Glass	34
36	Flat Roof Skylights	
	CMD Curb-Mounted Domed Polycarbonate	36
	CXP Domed Polycarbonate Hatch	36
	CFU CurveTech Glass	38
40	Flashing and Accessories	
	EKL/EKW Combi Flashing	40
	Shades	42
	Skylight Accessories	44
	Sun Tunnel® Accessories	46
48	Roof Windows	
	GPU Top-Hinged	48
	GXU Roof Access	50
	GDL Balcony	52
	GGU Center-Pivot	54
56	Architectural Skylights	
	Custom Skylight Systems: Pinnacle, Classic, Low Profile	56
	VMS VELUX Modular Skylights	58



HGTV
URBAN OASIS
PROUD SPONSOR
2023



VELUX Online Dealer Support

Dealer Support Center

The VELUX Dealer Support Center has everything you need to complete your VELUX orders. Through our online dealer support page, you can:

- Check warehouse inventory
- Create quick quotes
- Track your orders
- Locate product data
- And so much more!

Use your phone's camera to scan the QR code below to access the Dealer Support Center today.



DEALER SUPPORT CENTER
veluxsolutions.com/dealersupport

How to Order Your Product



Online - Dealer Extranet¹
dealerextranet3.veluxusa.com

Hours of Operation
24 hours a day, 7 days a week



Email
ordersusa@velux.com



Call Residential
1-800-888-3589

Hours of Operation (ET)
(Mon - Fri) 7:30 a.m. - 8 p.m.
(Sat) 9 a.m. - 5 p.m.



Call/Email Commercial
1-800-888-3589
commercialteam@velux.com

Hours of Operation (ET)
(Mon - Fri) 7:30 a.m. - 8 p.m.
(Sat) 9 a.m. - 5 p.m.



¹ Dealer Extranet allows a dealer to order products and perform routine inquiries 24/7 using real-time pricing and inventory availability.

Plan for Delivery Time

- S** In-stock at regional warehouses
Allow 2 - 4 bus. days
- A** In-stock at Sparks, NV region
Allow 2 - 3 bus. days; other areas call for availability
- B** At Sparks, NV and White Marsh, MD
Allow 2 - 5 bus. days
- C** In-stock at Greenwood, SC and Kent, WA regions
Allow 2 - 5 bus. days
- T** Trans-shipped from central warehouse
Allow 7 - 10 bus. days
- F** In-stock at Greenwood, SC and Sparks, NV regions
Allow 2 - 4 bus. days; other areas allow 7 - 10 bus. days
- G** In-stock at Greenwood, SC, Aurora, IL, and Sparks, NV
Allow 2 - 3 bus. days; other areas allow 5 - 7 bus. days
- R** Not stocked; Manufactured on demand
Allow approximately 10 bus. days
- D** Not stocked; Manufactured on demand
Allow approximately 26 bus. days
- N** Not stocked; Manufactured on demand
Allow approximately 37 bus. days
- L** Not Stocked; Manufactured on demand
Allow approximately 50 bus. days

Please note: large orders may be subject to additional ship times

Order Code Examples

 Skylights $\frac{VSS}{\text{product}} + \frac{C01}{\text{size}} + \frac{2004S}{\text{code}}$
 Sun Tunnel Skylights $\frac{TMR}{\text{product}} + \frac{010}{\text{size}} + \frac{0000}{\text{code}} + \frac{SL}{\text{light}}$

A new skylight experience from VELUX



Meet the Complete VELUX Skylight System

Designed for Better Everyday Living.

Beginning this year, remote-controlled solar-powered shades will be included as the standard in most VELUX glass skylights!

Introducing the VELUX Skylight System, a complete daylighting experience that makes the very most of skylights and the benefits they provide. The main component that makes Skylight Systems stand out as a better alternative is the remote-controlled, solar-powered shade, which comes factory-installed in each unit.

VELUX Skylight Systems are available in fixed and venting models, as well as in curb-mount, deck-mount, and self-flashed installation configurations.

Each Skylight System consists of:

- The world-class VELUX glass unit skylight
- A solar-powered, room-darkening white skylight shade
- Pre-paired remote controls for each skylight and shade
- Compatible VELUX flashing kits* are available for a waterproof seal and to qualify for our industry-leading installation warranty

*Flashing kits sold and packaged separately.

The VELUX Skylight System

Includes Skylight, Shade, and Remote Control

- 1 Unit Skylight**

The base of the VELUX Skylight System is our industry-leading skylight! With deck-mount, curb-mount, and self-flashed installation options, the skylight can be fixed or venting to provide fresh air. Venting models are available in solar-powered (pictured below), electric, and manual operations.
- 2 Solar-Powered Shade**

The included room-darkening skylight shade is solar-powered and offers total light control, increasing the Skylight System's energy performance up to 45%*. *Actual percentage varies by skylight model and size
- 3 Remote Controls**

Factory-paired remote controls for shades are included in all Skylight Systems for easy set-up and operation. Electric and solar venting Skylight Systems also include remotes pre-paired to open and close the skylights. **Manual venting Skylight Systems can be operated with a handle or control rod, sold separately. See all remote and control options on page 44.**
- 4 Standard Safety Glass**

Standard laminated glass has advanced Low-E protective coating, dual-sealed and injected with argon gas for increased protection and indoor comfort. **See all glass options on page 6.**
- 5 Rain Sensors**

Solar and electric venting Skylight Systems feature integrated rain sensors to close the skylights automatically at the first signs of inclement weather.
- 6 Insect Screens**

All venting Skylight Systems include insect screens to prevent bugs and debris from entering the home through an open skylight.
- 7 Weathertight Guarantee**

VELUX flashing is required to create a weathertight seal around deck- and curb-mount Skylight Systems, as well as to qualify for our 10-year installation warranty. **Flashing kits packaged and sold separately. See page 6.**

VELUX Skylight Systems available in venting and fixed models.



Why Skylight Shades?

It's simple: a skylight isn't complete without a shade! VELUX skylights have always provided abundant natural light, and now it is the standard that they also provide light control. Not only does this create a better user experience, adding solar-powered shades to skylights also improves their energy efficiency and helps create an overall more sustainable home.

Shades Benefits for Pros

- The competitively priced VELUX Skylight System – a skylight with a shade – satisfies a top homeowner desire (light and climate control) while increasing your revenue.
- Increased engagement with the Skylight System through daily shade use helps drive referrals from your existing customers to new ones and distinguishes you from other local installers.
- With everything included, the Skylight System reduces the number of purchase choices for you to present and homeowners to make.
- Shade remotes are pre-paired and flashing is sold and packaged separately but shipped with the skylight and shade, so the Skylight System is ready to be installed on site.

Shades Benefits for Homeowners

- Preinstalled solar-powered shades deliver the ideal homeowner experience – total control over light and glare in the home.
- Skylight shades also offer climate control, blocking out heat in the hot summer sun and keeping more heat in during cold winters.
- Solar-powered shades increase skylight energy efficiency while natural light and ventilation from skylights allow homeowners to rely less on electricity.

Quick Reference Guide

Types of Installation

Deck-Mounted

Skylight is nailed directly to the roof-deck

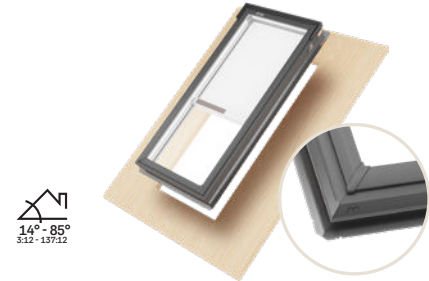

14° - 85°
3:12 - 137:12

Curb-Mounted

Skylight is installed on top of a site-built curb or frame attached to the roof



0° - 60°
0:12 - 20:12

Self-Flashed

Flashing is integrated into the skylight, so no additional kit is needed



10° - 60°
2:12 - 20:12

Flashing Systems Sold separately. Available for standard sizes only.

Deck-Mounted

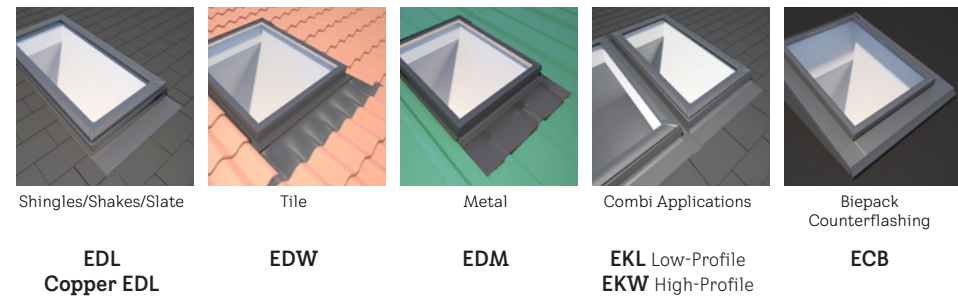

Shingles/Shakes/Slate **EDL** Copper EDL
 Tile **EDW**
 Metal **EDM**
 Combi Applications **EKL** Low-Profile **EKW** High-Profile
 Bi-pack Counterflashing **ECB**

Curb-Mounted

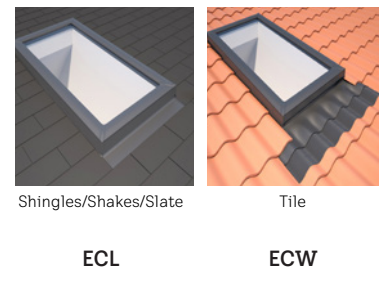

Shingles/Shakes/Slate **ECL**
 Tile **ECW**

Roof Pitch

Roof Pitch	Model	Page
Flat Roof	0° - 15° 0:12 - 3:12	CFU 38 CXP 36
	0° - 60° 0:12 - 20:12	VCS 10 VCE 10 VCM 14 FCM 20, 22 TZR 34 TCR 32 CMD 36
	1° - 60° ¼:12 - 20:12	GSM 30
Pitched Roof	10° - 60° 2:12 - 20:12	QPF 18 TZRL 34 TZRQ 34
	14° - 60° 3:12 - 20:12	TLR 32 TMR 32 TGR 32 TMF 32 TGF 32 TSR 33
	14° - 85° 3:12 - 137:12	VSS 8 VSE 8 VS 12 FS 16 EVMS 24 EV 26 EF 28
	15° - 55° 3:12 - 17:12	GPU 48
	15° - 85° 3:12 - 137:12	GXU 50
	15° - 90° 3:12 - 137:12	GGU 54
	35° - 53° 8.4:12 - 15:12	GDL 52

● Unit Skylight System
● Unit Skylight
● Sun Tunnel® Skylight
● Flat Roof Skylight
● Roof Window

Glass Options

Standard Safety Glass (xx04)
 This laminated glass is standard on all FS, VS, VSS, VSE, VCS, VCE, FCM, VCM, QPF, EV, EF, EVMS models.

Tempered Glass (xx05)
 Available with FCM only.

Impact Glass (xx06)
 Our toughest glass, resistant to penetration from wind-borne debris.

White Laminated Glass (xx08)
 Diffuses 100% of light flowing to the space below.

Snowload Glass (xx10)
 Reinforced glass to withstand added weight from accumulated snow.

Remote Comparison



VELUX Wall Switch

For customers who want simple control over a single or group of skylights or shades in one room.

VELUX Touch

For customers who want simple control over multiple skylights and shades with one remote.

VELUX App Control

For customers who wish for more benefits and smartphone control without full automation.

VELUX ACTIVE

For customers who wish to improve indoor air quality while gathering insights with smart automated ventilation and climate control.

	Included with Product	\$	\$	\$\$
Price				
Remote Operation Inside the Room	✓	✓	✓	✓
Remote Operation from Anywhere			✓	✓
Operate Multiple Ungrouped Products		✓	✓	✓
Requires Wi-Fi Connection			✓	✓
Compatible with Apple HomeKit® and Google Assistant™			✓	✓
Group Products		✓	✓	✓
Ventilation Timer		✓	✓	✓
Lock Home Option (close all skylights)		✓	✓	✓
Accessible to All Household Members	✓	✓	✓	✓
Scheduling to Personal Preferences			✓	✓
Voice Control			✓	✓
Sensor-based Automation				✓
Use of Weather Data				✓
Live Indoor Sensor Data				✓

The VELUX Skylight Guarantee

Our skylight warranty is our commitment that VELUX skylights installed with our flashing will stand strong in all types of weather. We're able to make this commitment with a 10-year installation warranty backed by our patented three layers of water protection on deck- and curb-mounted skylights.

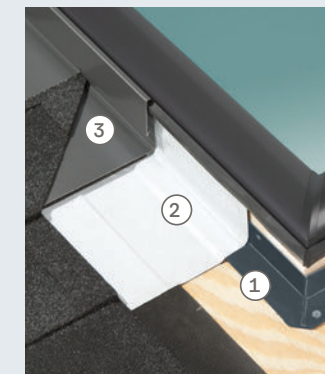

Deck-Mounted



Curb-Mounted

- 1 Pre-Attached Seal**
Pre-attached deck seal (deck-mounted) or gasket (curb-mounted) provides a tight seal for leak-proof installation.
- 2 Adhesive Underlayment**
Adhesive underlayment for secondary water protection against the harshest weather conditions.
- 3 Engineered Flashing**
Engineered flashing for easy installation and primary water protection. See page 6 for flashing systems.

Unit Skylight System

Deck-Mounted Solar/Electric Venting



VSS Solar
Fresh Air

VSE Electric
Fresh Air



14° - 85°
3:12 - 137:12

The Skylight System Includes:

- Pre-installed white room-darkening solar-powered shade
- Skylight and shade remotes
- Laminated safety glass
- Insect screen
- Rain sensor



The New VELUX Touch

Control all of your skylights and shades from one touch screen remote control.

KLR 300 WW | \$161

See page 7 for more information.



VELUX App Control

Automated scheduling and smart device control of your VELUX venting skylights and shades.

KIG 300 US | \$161



VELUX ACTIVE

Improve indoor air and climate quality with air quality sensors and smart automation of VELUX venting skylights and shades.

KIX 300 US | \$306

See page 7 for more information.



Unless noted, all base models include pre-installed room-darkening, double pleated white (1045) shade. Special order shades must be purchased separately. See page 42 for special order shade options.



Solar-Powered
Remote-Controlled
Shade
Pre-Installed
for Total Light &
Climate Control

HGTV
URBAN OASIS
PROUD SPONSOR
2023

Skylight System Prices Include Skylight, Solar-Powered Shade & Remote Control

Standard Sizes (W-in.xH-in.)	C01	C04	C06	C08	M02 ¹	M04	M06	M08	S01	S06
+ + Skylight Shade Remotes										
Rough Opening	21 x 26 7/8	21 x 37 7/8	21 x 45 3/4	21 x 54 7/16	30 1/16 x 30	30 1/16 x 37 7/8	30 1/16 x 45 3/4	30 1/16 x 54 7/16	44 1/4 x 26 7/8	44 1/4 x 45 3/4
Outside Frame	21 1/2 x 27 3/8	21 1/2 x 38 3/8	21 1/2 x 46 1/4	21 1/2 x 54 15/16	30 9/16 x 30 1/2	30 9/16 x 38 3/8	30 9/16 x 46 1/4	30 9/16 x 54 15/16	44 3/4 x 27 3/8	44 3/4 x 46 1/4

Base Model	C01	C04	C06	C08	M02 ¹	M04	M06	M08	S01	S06
Standard Safety Glass Stocked for all standard sizes	VELUX Skylight System Prices Include Skylight, Shade, and Remote Controls									
Code 2004S Delivery S	\$1,629	\$1,710	\$1,776	\$1,829	\$1,744	\$1,815	\$1,909	\$2,011	\$1,919	\$2,184

Optional Models² Add price to base model; any size. Applies to standard sizes only.

Impact Glass (Special Order) Contact Customer Service for pricing	Copper Cladding (Special Order) VSE only Contact Customer Service for pricing	Snowload Glass (Special Order) Contact Customer Service for pricing	Stain Grade Wood Interior ³ + \$60 (See details below) Code 0004S Delivery T
--	---	--	--

¹ Size M02 only stocked in VSS. ² Lead time/size availability may vary from base model. ³ VSS C04, C06, M06, M08, and S06 sizes stocked. VSE and other VSS standard sizes available as special order.

Flashing Adhesive underlayment included. VELUX flashing required for the 10-Year Installation Warranty and to complete the Skylight System.

Step	C01	C04	C06	C08	M02 ¹	M04	M06	M08	S01	S06
Asphalt Shingles/Wood Shake/Slate 1/2 in. max thickness Code EDL Delivery S		\$115		\$145			\$126			\$138
Copper Step ⁴ Asphalt Shingles/Wood Shakes/Slate 1/2 in. max thickness Code EDL COPPER Delivery D		\$243		\$307			\$266			\$292
High Profile ⁴ Tile - over 3/4 in. thickness Code EDW Delivery S		\$207		\$244			\$244			\$305
Metal Roof Code EDM Delivery S		\$370		\$410			\$397			\$421
Biepack ⁵ Counter Flashing for Deck-Mounted Code ECB Delivery S		\$249		\$249			\$284			\$301

⁴ VSE only. ⁵ Adhesive underlayment not included.

Order Code Example $\frac{\text{VSS}}{\text{product}} + \frac{\text{C06}}{\text{size}} + \frac{\text{2004S}}{\text{code}}$

Unit Skylight System

Curb-Mounted Solar/Electric Venting



0° - 60°
012 - 2012

VCS Solar
Fresh Air

VCE Electric
Fresh Air



The Skylight System Includes:

- Pre-installed white room-darkening solar-powered shade
- Skylight and shade remotes
- Laminated safety glass
- Insect screen
- Rain sensor



The New VELUX Touch

Control all of your skylights and shades from one touch screen remote control.

KLR 300 WW | \$161

See page 7 for more information.



VELUX App Control

Automated scheduling and smart device control of your VELUX venting skylights and shades.

KIG 300 US | \$161



VELUX ACTIVE

Improve indoor air and climate quality with air quality sensors and smart automation of VELUX venting skylights and shades.

KIX 300 US | \$306

See page 7 for more information.

Unless noted, all base models include pre-installed room-darkening, double pleated white (1045) shade. Special order shades must be purchased separately. See page 42 for special order shade options.

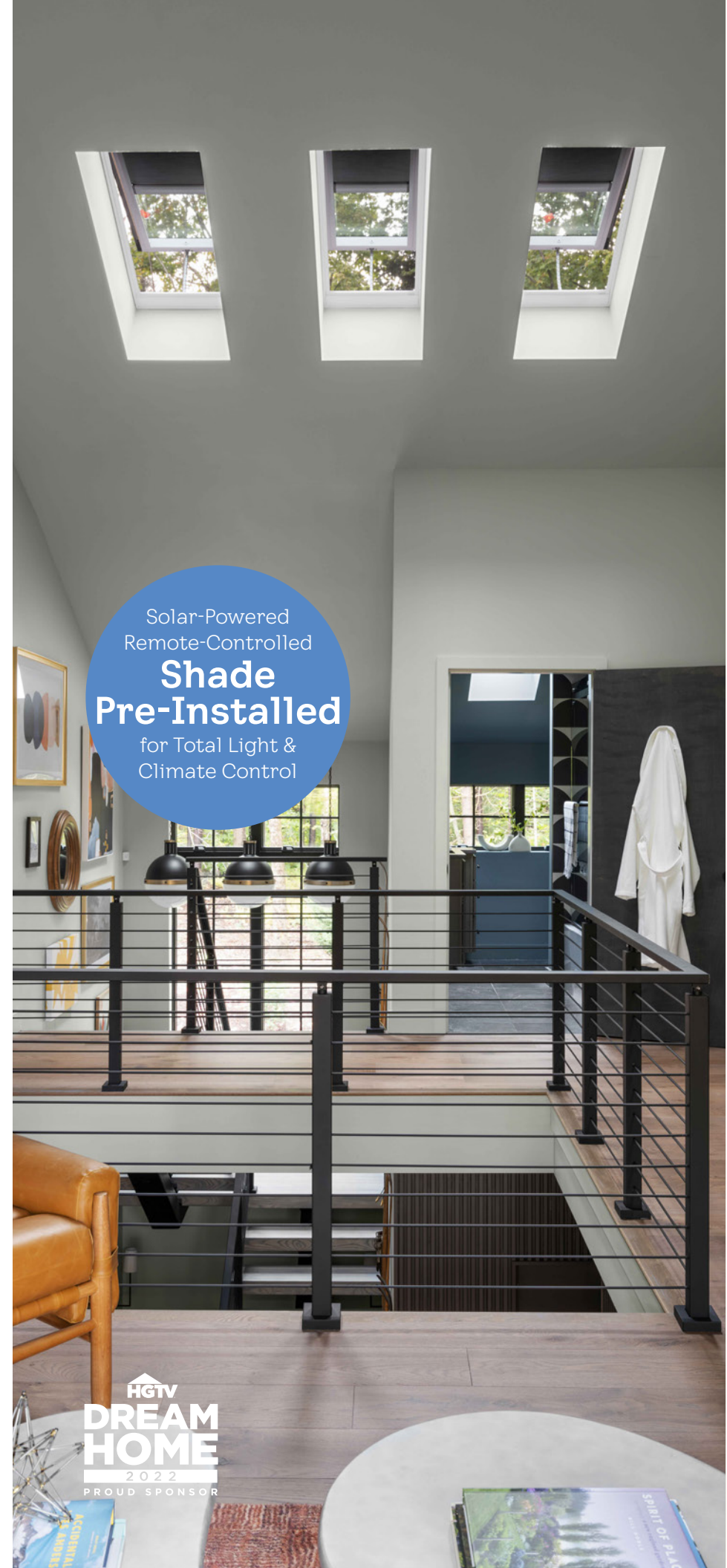

Solar-Powered Remote-Controlled
Shade Pre-Installed
for Total Light & Climate Control



Skylight System Prices Include Skylight, Solar-Powered Shade & Remote Control

Standard Sizes (W-in. x H-in.)	2222	2234	2246	3030	3046	3434	3737 ¹	4622 ¹	4630 ¹	4646
Skylight + Shade + Remotes										
Inside Curb	22 1/2 x 22 1/2	22 1/2 x 34 1/2	22 1/2 x 46 1/2	30 1/2 x 30 1/2	30 1/2 x 46 1/2	34 1/2 x 34 1/2	37 1/2 x 37 1/2	46 1/2 x 22 1/2	46 1/2 x 30 1/2	46 1/2 x 46 1/2
Outside Curb	25 1/2 x 25 1/2	25 1/2 x 37 1/2	25 1/2 x 49 1/2	33 1/2 x 33 1/2	33 1/2 x 49 1/2	37 1/2 x 37 1/2	40 1/2 x 40 1/2	49 1/2 x 25 1/2	49 1/2 x 33 1/2	49 1/2 x 49 1/2
Maximum Skylight Clearance	26 5/8 x 26 5/8	26 5/8 x 38 5/8	26 5/8 x 50 5/8	34 5/8 x 34 5/8	34 5/8 x 50 5/8	38 5/8 x 38 5/8	41 5/8 x 41 5/8	50 5/8 x 26 5/8	50 5/8 x 34 5/8	50 5/8 x 50 5/8

Base Model	2222	2234	2246	3030	3046	3434	3737 ¹	4622 ¹	4630 ¹	4646
Standard Safety Glass Stocked for all standard sizes	VELUX Skylight System Prices Include Skylight, Shade, and Remote Controls									
Code 2004S Delivery S	\$1,660	\$1,765	\$1,847	\$1,867	\$1,961	\$1,937	\$1,949/F	\$1,847	\$1,961/F	\$2,081

Optional Models² Add price to base model; any size. Applies to standard sizes only.

Impact Glass³

+ \$120 VCS only (See Details Below)

Code 2006S | Delivery T

White Laminated Glass (Special Order)

VCS only

Contact Customer Service for pricing

¹ VCS only. ² Lead time and size availability may vary from base model. ³ VCS only, excluding 4646. VCS 2222 and 2246 sizes stocked. Other standard VCS sizes available as special order.

Flashing Adhesive underlayment included. VELUX flashing required for the 10-Year Installation Warranty and to complete the Skylight System.

	2222	2234	2246	3030	3046	3434	3746 ¹	4622 ¹	4630 ¹	4646
Step 10° - 60° Asphalt Shingles/Wood Shake/Slate 1/2 in. max thickness		\$113		\$127		\$128	\$131/F		\$133	
Code ECL Delivery S										
High Profile 14° - 60° Tile - over 3/4 in. thickness		\$227		\$272		\$272	N/A		\$298	
Code ECW Delivery S										

Order Code Example $\frac{\text{VCS}}{\text{product}} + \frac{2246}{\text{size}} + \frac{2004S}{\text{code}}$

Unit Skylight System

Deck-Mounted Manual Venting



14° - 85°
3:12 - 137:12

VS Manual
Fresh Air



The Skylight System Includes:

- Pre-installed white room-darkening solar-powered shade
- Shade remote
- Laminated safety glass
- Insect screen



The New VELUX Touch

Control all of your shades from one touch screen remote control.

KLR 300 WW | \$161

See page 7 for more information.



VELUX App Control

Automated scheduling and smart device control of your VELUX shades.

KIG 300 US | \$161

Insect screen and operating hook included with VS skylight. Operated by ZCT 300 control rod or crank handle ZZZ 201, sold separately.

Unless noted, all base models include pre-installed room-darkening, double pleated white (1045) shade. Special order shades must be purchased separately. See page 42 for special order shade options.



Solar-Powered
Remote-Controlled
Shade
Pre-Installed
for Total Light &
Climate Control

Skylight System Prices Include Skylight, Solar-Powered Shade & Remote Control

Standard Sizes (W-in. x H-in.)	C01	C04	C06	C08	M02	M04	M06	M08	S01	S06
+ + Skylight Shade Remote										
Outside Frame	21 1/2 x 27 3/8	21 1/2 x 38 3/8	21 1/2 x 46 1/4	21 1/2 x 54 15/16	30 9/16 x 30 1/2	30 9/16 x 38 3/8	30 9/16 x 46 1/4	30 9/16 x 54 15/16	44 3/4 x 27 3/8	44 3/4 x 46 1/4
Rough Opening	21 x 26 7/8	21 x 37 7/8	21 x 45 3/4	21 x 54 7/16	30 1/16 x 30	30 1/16 x 37 7/8	30 1/16 x 45 3/4	30 1/16 x 54 7/16	44 1/4 x 26 7/8	44 1/4 x 45 3/4

Base Model	C01	C04	C06	C08	M02	M04	M06	M08	S01	S06
Standard Safety Glass Stocked for all standard sizes	VELUX Skylight System Prices Include Skylight, Shade, and Remote Control									
Code 2004S Delivery S	\$884	\$932	\$970	\$1,003	\$961	\$994	\$1,048	\$1,129	\$1,051	\$1,246

Optional Models¹ Add price to base model; any size. Applies to standard sizes only.

Impact Glass (Special Order) Contact Customer Service for pricing	Copper Cladding (Special Order) Contact Customer Service for pricing	Snowload Glass (Special Order) Contact Customer Service for pricing	Stain Grade Wood Interior ² + \$60 (See details below) Code 0004S Delivery T
--	---	--	--

¹ Lead time/size availability may vary from base model. ² VS C04, C06, M06, M08, and S06 sizes stocked. Other standard sizes available as special order.

Flashing Adhesive underlayment included. VELUX flashing required for the 10-Year Installation Warranty and to complete the Skylight System.

	C01	C04	C06	C08	M02	M04	M06	M08	S01	S06
Step Asphalt Shingles/Wood Shake/Slate 1/2 in. max thickness Code EDL Delivery S		\$115		\$145			\$126			\$138
Copper Step Asphalt Shingles/Wood Shakes/Slate 1/2 in. max thickness Code EDL COPPER Delivery D		\$243		\$307			\$266			\$292
High Profile Tile - over 3/4 in. thickness Code EDW Delivery S		\$207		\$244			\$244			\$305
Metal Roof Code EDM Delivery S		\$370		\$410			\$397			\$421
Bi-pack³ Counter Flashing for Deck-Mounted Code ECB Delivery S		\$249		\$249			\$284			\$301

³ Adhesive underlayment not included.

Order Code Example $\frac{\text{VS}}{\text{product}} + \frac{\text{C06}}{\text{size}} + \frac{\text{2004S}}{\text{code}}$

Unit Skylight System

Curb-Mounted Manual Venting



VCM Manual
Fresh Air

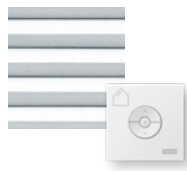

The Skylight System Includes:

- Pre-installed white room-darkening solar-powered shade
- Shade remote
- Laminated safety glass
- Insect screen



The New VELUX Touch

Control all of your shades from one touch screen remote control.

KLR 300 WW | \$161

See page 7 for more information.



VELUX App Control

Automated scheduling and smart device control of your VELUX shades.

KIG 300 US | \$161



Solar-Powered
Remote-Controlled
Shade
Pre-Installed
for Total Light & Climate Control

Skylight System Prices Include Skylight, Solar-Powered Shade & Remote Control

Standard Sizes (W-in. x H-in.)	2222	2234	2246	3030	3046	3434	4646
+ + Skylight Shade Remote							
Inside Curb	22 1/2 x 22 1/2	22 1/2 x 34 1/2	22 1/2 x 46 1/2	30 1/2 x 30 1/2	30 1/2 x 46 1/2	34 1/2 x 34 1/2	46 1/2 x 46 1/2
Outside Curb	25 1/2 x 25 1/2	25 1/2 x 37 1/2	25 1/2 x 49 1/2	33 1/2 x 33 1/2	33 1/2 x 49 1/2	37 1/2 x 37 1/2	49 1/2 x 49 1/2
Maximum Skylight Clearance	26 5/8 x 26 5/8	26 5/8 x 38 5/8	26 5/8 x 50 5/8	34 5/8 x 34 5/8	34 5/8 x 50 5/8	38 5/8 x 38 5/8	50 5/8 x 50 5/8
Base Model	2222	2234	2246	3030	3046	3434	4646
Standard Safety Glass Stocked for all standard sizes Code 2004S Delivery S	VELUX Skylight System Prices Include Skylight, Shade, and Remote Control						
	\$863	\$954	\$1,011	\$1,064	\$1,274	\$1,175	\$1,422

Optional Models¹ Add price to base model; any size. Applies to standard sizes only.

Impact Glass (Special Order) | White Laminated Glass (Special Order)
 Contact Customer Service for pricing | Contact Customer Service for pricing

¹Lead time/size availability may vary from base model.

Flashing Adhesive underlayment included. VELUX flashing required for the 10-Year Installation Warranty and to complete the Skylight System.

	2222	2234	2246	3030	3046	3434	4646
Step 10° - 60° Asphalt Shingles/Wood Shake/Slate 1/2 in. max thickness Code ECL Delivery S		\$113		\$127		\$128	\$133
High Profile 14° - 60° Tile - over 3/4 in. thickness Code ECW Delivery S		\$227		\$272		\$272	\$298

Order Code Example $\frac{\text{VCM}}{\text{product}} + \frac{2246}{\text{size}} + \frac{2004S}{\text{code}}$

Insect screen and operating hook included with VCM skylight. Operated by ZCT 300 control rod or crank handle ZZZ 212, sold separately.

Unless noted, all base models include pre-installed room-darkening, double pleated white (1045) shade. Special order shades must be purchased separately. See page 42 for special order shade options.

Unit Skylight System

Deck-Mounted Fixed



FS Fixed



The Skylight System Includes:

- Pre-installed white room-darkening solar-powered shade
- Shade remote
- Laminated safety glass



The New VELUX Touch

Control all of your shades from one touch screen remote control.

KLR 300 WW | \$161

See page 7 for more information.



VELUX App Control

Automated scheduling and smart device control of your VELUX shades.

KIG 300 US | \$161

Unless noted, all base models include pre-installed room-darkening, double pleated white (1045) shade. Special order shades must be purchased separately. See page 42 for special order shade options.



Solar-Powered Remote-Controlled
Shade
Pre-Installed
for Total Light & Climate Control

HGTV
URBAN OASIS
PROUD SPONSOR
2022

Skylight System Prices Include Skylight, Solar-Powered Shade & Remote Control

Standard Sizes (W-in. x H-in.)	A06	C01	C04	C06	C08	C12	D26	D06	M02	M04	M06	M08	S01	S06
+ + Skylight Shade Remote														
Outside Frame	15 1/4 x 46 1/4	21 1/2 x 27 3/8	21 1/2 x 38 3/8	21 1/2 x 46 1/4	21 1/2 x 54 15/16	21 1/2 x 70 3/4	23 1/4 x 23 7/16	23 1/4 x 46 1/4	30 9/16 x 30 1/2	30 9/16 x 38 3/8	30 9/16 x 46 1/4	30 9/16 x 54 15/16	44 3/4 x 27 3/8	44 3/4 x 46 1/4
Rough Opening	14 1/2 x 45 3/4	21 x 26 7/8	21 x 37 7/8	21 x 45 3/4	21 x 54 7/16	21 x 70 1/4	22 1/2 x 22 15/16	22 1/2 x 45 3/4	30 1/16 x 30	30 1/16 x 37 7/8	30 1/16 x 45 3/4	30 1/16 x 54 7/16	44 1/4 x 26 7/8	44 1/4 x 45 3/4
Base Model	A06	C01	C04	C06	C08	C12	D26	D06	M02	M04	M06	M08	S01	S06
Standard Safety Glass Stocked for all standard sizes	VELUX Skylight System Prices Include Skylight, Shade, and Remote Control													
Code 2004S Delivery S	\$616	\$577	\$624	\$665	\$696	\$816	\$603	\$677	\$654	\$687	\$742	\$786	\$746	\$872

Optional Models¹ Add price to base model; any size. Applies to standard sizes only.

Impact Glass ² + \$120 C12 Not Eligible (See details below) Code 2006S Delivery T	Copper Cladding (Special Order) Contact Customer Service for pricing	Snowload Glass (Special Order) Contact Customer Service for pricing	Stain Grade Wood Interior ³ + \$60 (See details below) Code 0004S Delivery T
--	---	--	--

¹ Lead time/size availability may vary from base model. ² FS C04, C06, M06, M08, and S06 sizes stocked Other standard sizes, excluding C12, available as special order. ³ FS C04, C06, M06, M08, and S06 sizes stocked. Other standard sizes available as special order.

Flashing Adhesive underlayment included. VELUX flashing required for the 10-Year Installation Warranty and to complete the Skylight System.

	A06	C01	C04	C06	C08	C12	D26	D06	M02	M04	M06	M08	S01	S06
Step Asphalt Shingles/Wood Shake/Slate 1/2 in. max thickness Code EDL Delivery S	\$108	\$115			\$145		\$122			\$126				\$138
Copper Step Asphalt Shingles/Wood Shakes/Slate 1/2 in. max thickness Code EDL COPPER Delivery D	\$228	\$243			\$307		\$258			\$266				\$292
High Profile Tile - over 3/4 in. thickness Code EDW Delivery S	N/A	\$207			\$244		\$256			\$244				\$305
Metal Roof Code EDM Delivery S	\$337	\$370			\$410		\$383			\$397				\$421
Biopack⁴ Counter Flashing for Deck-Mounted Code ECB Delivery S	N/A	\$249			\$249	N/A	N/A			\$284				\$301

⁴ Adhesive underlayment not included.

Order Code Example $\frac{\text{FS}}{\text{product}} + \frac{\text{C06}}{\text{size}} + \frac{\text{2004S}}{\text{code}}$

Unit Skylight System

Self-Flashed Fixed



QPF Fixed



The Skylight System Includes:

- Pre-installed white room-darkening solar-powered shade
- Shade remote
- Laminated safety glass



The New VELUX Touch

Control all of your shades from one touch screen remote control.

KLR 300 WW | \$161

See page 7 for more information.



VELUX App Control

Automated scheduling and smart device control of your VELUX shades.

KIG 300 US | \$161

Unless noted, all base models include pre-installed room-darkening, double pleated white (1045) shade. Special order shades must be purchased separately. See page 42 for special order shade options.



Solar-Powered Remote-Controlled
Shade
Pre-Installed
for Total Light & Climate Control



Skylight System Prices Include Skylight, Solar-Powered Shade & Remote Control

Standard Sizes (W-in. x H-in.)	2222	2230	2246	3030	3046	4646
+ + Skylight Shade Remote						
Outside Flashing	29 5/8 x 29 5/8	29 5/8 x 37 5/8	29 5/8 x 53 5/8	37 5/8 x 37 5/8	37 5/8 x 53 5/8	53 5/8 x 53 5/8
Rough Opening/ Finished Frame	22 1/2 x 22 1/2	22 1/2 x 30 1/2	22 1/2 x 46 1/2	30 1/2 x 30 1/2	30 1/2 x 46 1/2	46 1/2 x 46 1/2

Base Model	2222	2230	2246	3030	3046	4646
Standard Safety Glass Stocked for all standard sizes Code 2004S Delivery S	VELUX Skylight System Prices Include Skylight, Shade, and Remote Control					
	\$583	\$642	\$667	\$668	\$759	\$920

Optional Models¹ Add price to base model; any size. Applies to standard sizes only.

Impact Glass (Special Order)
Contact Customer Service for pricing

¹ Lead time/size availability may vary from base model.

Order Code Example $\frac{\text{QPF}}{\text{product}} + \frac{2246}{\text{size}} + \frac{2004S}{\text{code}}$

Unit Skylight System

Curb-Mounted Fixed



FCM Fixed

The Skylight System Includes:

- White room-darkening solar-powered shade
- Shade accessory tray
- Shade remote
- Laminated safety glass

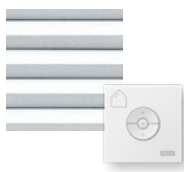

The New VELUX Touch

Control all of your shades from one touch screen remote control.

KLR 300 WW | \$161

See page 7 for more information.



VELUX App Control

Automated scheduling and smart device control of your VELUX shades.

KIG 300 US | \$161



Order Code Example $\frac{\text{FCM}}{\text{product}} + \frac{2246}{\text{size}} + \frac{2004S}{\text{code}}$

Custom sizes available, see page 22.

Factory installed shades for FCM skylights includes accessory tray.

Unless noted, all base models include pre-installed room-darkening, double pleated white (1045) shade. Special order shades must be purchased separately. See page 42 for special order shade options.



Solar-Powered Remote-Controlled
Shade Pre-Installed
for Total Light & Climate Control



Skylight System Prices Include Skylight, Solar-Powered Shade & Remote Control

Standard Sizes (W-in. x H-in.)	1943	2222	2230	2234	2246	2270	2347	3030
Skylight + Shade + Remote								
Inside Curb	19 1/2 x 43 1/2	22 1/2 x 22 1/2	22 1/2 x 30 1/2	22 1/2 x 34 1/2	22 1/2 x 46 1/2	22 1/2 x 70 1/2	23 1/2 x 47 1/2	30 1/2 x 30 1/2
Outside Curb	22 1/2 x 46 1/2	25 1/2 x 25 1/2	25 1/2 x 33 1/2	25 1/2 x 37 1/2	25 1/2 x 49 1/2	25 1/2 x 73 1/2	26 1/2 x 50 1/2	33 1/2 x 33 1/2
Maximum Skylight Clearance	23 1/8 x 47 5/8	26 5/8 x 26 5/8	26 5/8 x 34 5/8	26 5/8 x 38 5/8	26 5/8 x 50 5/8	26 5/8 x 74 5/8	27 5/8 x 51 5/8	34 5/8 x 34 5/8
Base Model	1943	2222	2230	2234	2246	2270	2347	3030
Standard Safety Glass Stocked for all standard sizes	VELUX Skylight System Prices Include Skylight, Shade, and Remote Control							
Code 2004S Delivery S	\$779	\$416	\$454	\$471	\$488	\$691	\$820	\$510

Standard Sizes Continued	3046	3055	3171	3422	3434	3446	4622	4630	4646	4672
Skylight + Shade + Remote										
Inside Curb	30 1/2 x 46 1/2	30 1/2 x 55 1/2	32 x 72	34 1/2 x 22 1/2	34 1/2 x 34 1/2	34 1/2 x 46 1/2	46 1/2 x 22 1/2	46 1/2 x 30 1/2	46 1/2 x 46 1/2	46 1/2 x 72 1/2
Outside Curb	33 1/2 x 49 1/2	33 1/2 x 58 1/2	35 x 75	37 1/2 x 25 1/2	37 1/2 x 37 1/2	37 1/2 x 49 1/2	49 1/2 x 25 1/2	49 1/2 x 33 1/2	49 1/2 x 49 1/2	49 1/2 x 75 1/2
Maximum Skylight Clearance	34 5/8 x 50 5/8	34 5/8 x 59 5/8	36 1/8 x 76 1/8	38 5/8 x 26 5/8	38 5/8 x 38 5/8	38 5/8 x 50 5/8	50 5/8 x 26 5/8	50 5/8 x 34 5/8	50 5/8 x 50 5/8	50 5/8 x 76 5/8
Base Model Continued	3046	3055	3171	3422	3434	3446	4622	4630	4646	4672
Standard Safety Glass Stocked for all standard sizes	VELUX Skylight System Prices Include Skylight, Shade, and Remote Control									
Code 2004S Delivery S	\$618	\$664	\$1,090	\$471	\$588	\$639	\$488	\$618	\$659	\$988

Optional Models¹ Add price to base model; any size. Applies to standard sizes only.

Impact Glass²
+ \$120 (See details below)
Code 2006S | Delivery T

White Laminated Glass³
+ \$40 (See details below)
Code 2008S | Delivery B

Triple Pane Glass
Contact Customer Service for pricing

¹Lead time/size availability may vary from base model. ²FCM 2222, 2234, 2246, 3030, 3046, 3434, and 4646 sizes stocked. Other standard sizes, excluding 2270, 3055, and 4672, are available as special order. ³FCM 2222, 2234, 2246, 2270, 3030, 3046, 3434, 4622, and 4646 sizes stocked. Other standard sizes available as special order as a third line to the note.

	2222	2246	4646
Tempered Glass Sizes 2222, 2246, and 4646 only	VELUX Skylight System Prices Include Skylight, Shade, and Remote Control		
Code 2005S Delivery S	\$374	\$446	\$614

Flashing Adhesive underlayment included. VELUX flashing required for the 10-Year Installation Warranty and to complete the Skylight System.

	1430	1446	2222	2230	2234	2246	2270	3030	3046	3055	3422	3434	3446	4622	4630	4646	4672
Step 10° - 60° Asphalt Shingles/Wood Shake/Slate 1/2 in. max thickness		\$113		\$113		\$113	\$127	\$209*		\$128		\$133		\$133		\$215*	
Code ECL Delivery S																	
High Profile 14° - 60° Tile - over 3/4 in. thickness		\$214		\$227		\$227	\$272	N/A		\$272		\$298		N/A		N/A	
Code ECW Delivery S																	

*Includes extra step flashing and adhesive underlayment.

Custom Size Skylights

Curb-Mounted FCM



FCM Fixed

Flashing kits not available on custom FCM sizes.



FCM roof pitch

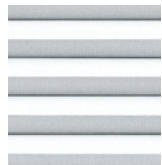

Add a Solar-Powered Shade

Room-Darkening or Light-Filtering
See page 43 for special order shade options.
Accessory tray required for shades.
Custom shade Make Size (Maximum Skylight Clearance) range: Minimum 19" x 19", maximum 49.5" x 75.5"



The New VELUX Touch

Control all of your shades from one touch screen remote control.
KLR 300 WW | \$161
See page 7 for more information.



VELUX App Control

Automated scheduling and smart device control of your VELUX shades.
KIG 300 US | \$161



HGTV
SMART HOME
PROUD SPONSOR
2023

Standard Sizes	1430*	1446*	190365	190435	225225	225470	315470	315700	315715*	365365
Flashed Outside Curb Width Range	14 1/2 x 30 1/2	14 1/2 x 46 1/2	22 - 23 1/2	22 - 23 1/2	25 1/2 - 27	25 1/2 - 27	34 1/2 - 36	34 1/2 - 36	34 1/2 - 36	39 1/2 - 41
Flashed Outside Curb Height Range	17 1/2 x 33 1/2	17 1/2 x 49 1/2	39 1/2 - 41	46 1/2 - 48	25 1/2 - 27	50 - 51 1/2	50 - 51 1/2	73 - 74 1/2	74 1/2 - 76	39 1/2 - 41
Maximum Skylight Clearance (W" or H")	18 5/8 x 34 5/8	18 5/8 x 50 5/8	23 5/8 x 41 1/8	23 5/8 x 48 1/8	27 1/8 x 27 1/8	27 1/8 x 51 5/8	36 1/8 x 51 5/8	36 1/8 x 74 5/8	36 1/8 x 76 1/8	41 1/8 x 41 1/8
Laminated LowE ³ Glass Code 0004 Delivery C	\$285	\$313	\$541	\$593	\$434	\$634	\$715	\$799	\$904	\$668

Flashed Outside Curb Range

Standard clearance between flashed outside curb and counterflashing leg:

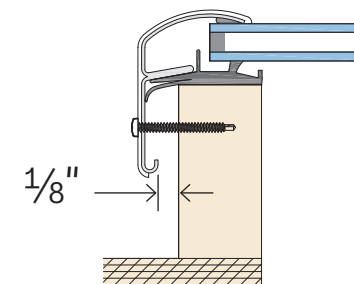

FCM can accommodate a smaller curb (-3/4") and still use the same skylight. Longer screws are provided as distance between the flashed outside curb and counterflashing increases.

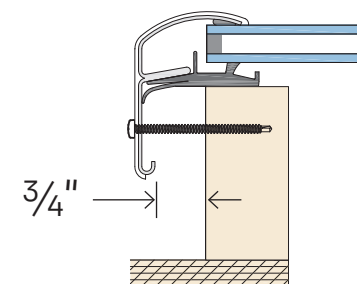

Solar-Powered Shades

Shades are not available for sizes 1430, 1446, or 315715.



In-Stock Skylight Shade

White Room-Darkening (1045)

- Custom size shades are only available for factory installation when White Room-Darkening (1045) is desired.

Special Order Skylight Shade Options

- Room-Darkening or Light-Filtering, see page 43
- Custom size special order shades are available in all colors, room darkening or light filtering. See page 43 for special order shade options. Shade and skylight will ship separately.

* Shades are not available. Custom shade Make Size (Maximum Skylight Clearance) range: Minimum 19" x 19", maximum 49.5" x 75.5".

Custom Size Skylights

Curb-Mounted FCM



FCM Fixed

Flashing kits not available on custom FCM sizes.



FCM roof pitch

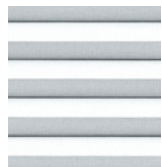

Add a Solar-Powered Shade

Room-Darkening or Light-Filtering

See page 43 for special order shade options.

Accessory tray required for shades.

Custom shade Make Size (Maximum Skylight Clearance) range: Minimum 19" x 19", maximum 49.5" x 75.5"



The New VELUX Touch

Control all of your shades from one touch screen remote control.

KLR 300 WW | \$161

See page 7 for more information.



VELUX App Control

Automated scheduling and smart device control of your VELUX shades.

KIG 300 US | \$161



Custom Size FCM

Call for pricing and availability

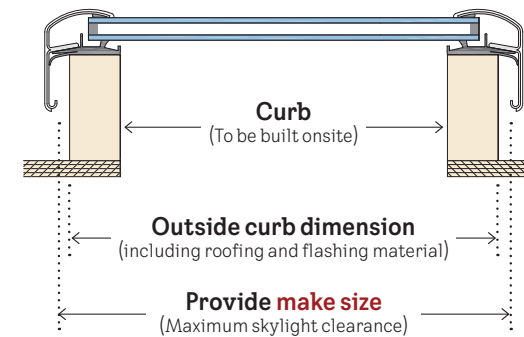

Make size range

Width 18 3/4" to 50 3/4"

Length 18 3/4" to 76 1/2"

- We require maximum skylight clearance dimensions in 1/4" increments (0, 1/4, 1/2, 3/4) for width and height
- Custom size flashing kits are not available
- Some specialty glass options require longer lead times

Without Shade Allow 15 days or less¹

Skylight System (with Shade) Allow 26 days or less¹

Custom Size Shades



Make size range

Minimum 19" x 19"

Maximum 49 1/2" x 75 1/2"

In-Stock Skylight Shade

White Room-Darkening (1045)

- Custom size shades are only available for factory installation when Room Darkening White (1045) is desired.

Special Order Skylight Shade Options

Room-Darkening or Light-Filtering, see page 43

- Custom size special order shades are available in all colors, room darkening or light filtering. See page 43 for special order shade options. Shade and skylight will ship separately.
- Lead times 26 - 37 days depending on variant¹

¹ Some specialty glass options and configurations require longer leadtimes.

Custom Size Skylights

Self-Flashed E-Class Venting



EVMS Solar
Fresh Air

EV Manual
Fresh Air

EVMS: Remote and insect screen included with EVMS skylight. Shades not available

EV: Insect screen and operating hook included with EV skylight. Operated by ZCT 300 control rod or crank handle ZZZ 201, sold separately. Shades not available.



EVMS/EV Roof Pitch

Custom Sizes 1-800-888-3589
Call for pricing

Remote Upgrade Upgrade to the VELUX Touch: Simple control of multiple EVMS skylights with one remote
\$161 EVMS model only. See page 6 for more information.

- Ready to install right out of the box shingle/slate/wood roofs up to 3/4" thickness.
- One-piece, impenetrable ultra-seal integrated flashing.
- Requires no sealants.



How to Order Custom EVMS & EV Skylights

We require exact rough opening (RO) dimensions for width and height.
Up to 15 sq ft | Min RO: 22 1/4" W or H | Max RO: 48" W or 54" H | Delivery N

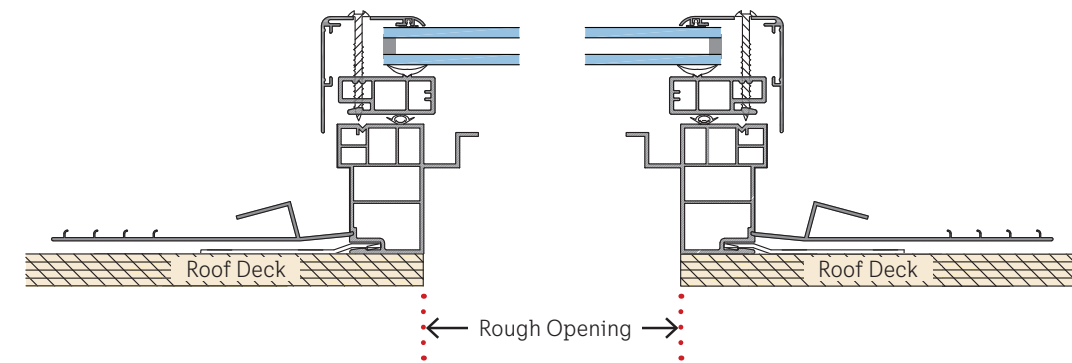

Choose Your Glass

- Laminated White Laminated

EVMS & EV Custom Finish Colors

VELUX Neutral Grey AAMA 2604 powder coat finish standard.
Other custom finish colors are available, call 1-800-888-3589 for pricing and lead time information.

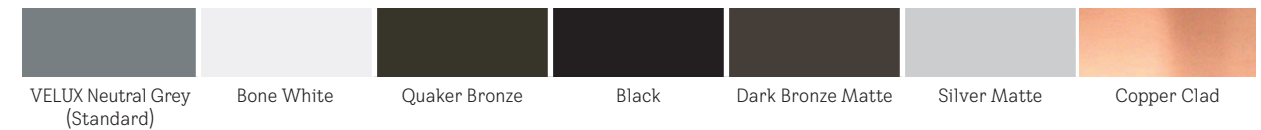

How to Place Your Order

1. _____ Width
(dimension parallel to ridge)
2. _____ Height
3. Call **1-800-888-3589**
(for pricing)

Custom Size Skylights

Self-Flashed E-Class Fixed



EF Fixed

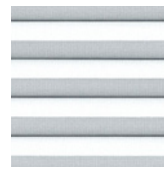

Add a Solar-Powered Shade

Room-Darkening or Light-Filtering
See page 43 for special order shade options.
Accessory tray required for shades.



The New VELUX Touch

Control all of your shades from one touch screen remote control.

KLR 300 WW | \$161

See page 7 for more information.



VELUX App Control

Automated scheduling and smart device control of your VELUX shades.

KIG 300 US | \$161



How to Order Custom EF Skylights

We require exact rough opening (RO) dimensions for width and height.
Up to 23 sq ft | Min RO: 14 1/2" W or H | Max RO: 72" W or H | Delivery N

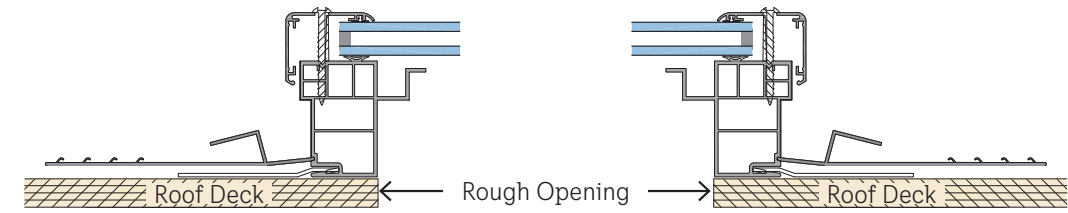

Choose Your Glass

- Laminated
- White Laminated

EF Custom Finish Colors

VELUX Neutral Grey AAMA 2604 powder coat finish standard.
Other custom finish colors are available, call 1-800-888-3589 for pricing and lead time information.

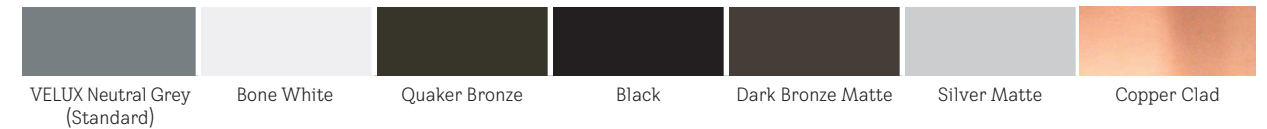

How to Place Your Order

1. _____ Width
(dimension parallel to ridge)
2. _____ Height
3. Call **1-800-888-3589**
(for pricing)

Custom Size Skylights

Curb-Mounted SkyMax



GSM Fixed

Custom Sizes up to 35 sq ft
 1-800-888-3589
 Call for pricing

- Sizes are based upon the outside curb dimension (OCD).
- For use with site-built curb and flashing minimum 3 1/2 curb.
- Available custom finish colors and copper cladding.



Standard Sizes (W-in. x H-in.)	4896	5199
Inside Curb Dimension	45 x 93	48 x 96
Outside Curb Dimension	48 x 96	51 x 99
Max Skylight Clearance	49 1/4 x 97 1/4	52 1/4 x 100 1/4
Base Model	4896	5199
Laminated LowE ³ Glass Code 0090	\$2,781/B	\$2,851/R

Optional Models¹ Other glass options available as custom.

¹Lead time/size availability may vary from base model. Additional models do not apply to custom sizes.

Order Code Example $\frac{\text{GSM}}{\text{product}} + \frac{4896}{\text{size}} + \frac{0090}{\text{code}}$

Call 1-800-888-3589 for sizes 4896 and 5199 listed above.

How to Order Custom SkyMax GSM Skylights

We require exact outside curb dimensions (OCD) for width and height

Up to 35 sq ft (OCD)
 Min OCD: 17" W or H
 Max OCD: 120" W or H

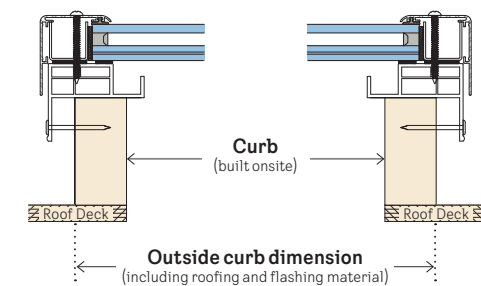

GSM Custom Finish Colors

VELUX Neutral Grey finish standard. The standard finish type is a powder coat finish meeting AAMA 2604 requirements. Custom Finish colors shown are available to meet both AAMA 2604 and 2605 requirements. Other custom finish colors are available, call 1-888-878-3589 for pricing and lead time information.

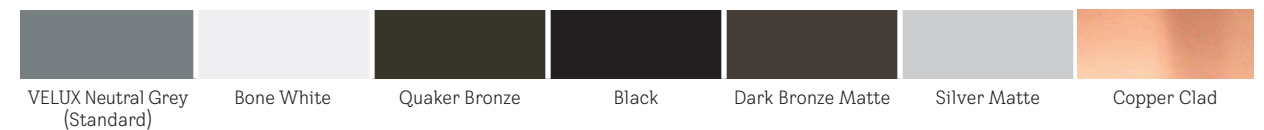

How to Place Your Order

1. _____ Width
(dimension parallel to ridge)
2. _____ Height
3. Call **1-800-888-3589**
(Call Customer Service for custom size pricing)

Sun Tunnel® Skylights

Rigid & Flex Tube



TGR

Rigid One-piece Low-profile Metal Flashing



TGF

Flexible One-piece Low-profile Metal Flashing



TMR

Rigid Pitched One-piece Metal Flashing



TMF

Flexible Pitched One-piece Metal Flashing



TLR

Rigid Low-profile Flat Glass



TCR

Rigid Curb Metal Counterflashing



Roof Pitch:
TGR, TMR, TSR,
TGF, TMF, TLR



Roof Pitch:
TCR



HGTV
SMART HOME
PROUD SPONSOR
2023

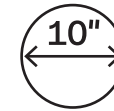

10" Sun Tunnel	TGR 010	TSR 010	TMR 010
Tube length with kit Rigid kits include 2 elbows & 24" extension	48"	48"	48"
Tube type	Rigid	Rigid	Rigid
Maximum recommended installation length	20'	20'	20'

Dome/Flashing	TGR 010	TSR 010	TMR 010
Acrylic Dome Shingle/shake roof Code 0000 Delivery S	\$316	N/A	\$316
Impact Dome Shingle/shake roof Code 1000 Delivery T	\$341	N/A	\$341
Acrylic Dome Plastic/metal flashing - shingle/shake roof Code 0000 Delivery S	N/A	\$232	N/A



14" Sun Tunnel	TGR 014	TMR 014	TLR 014	TCR 014	TMF 014	TGF 014
Tube length with kit Rigid kits include 2 elbows & 24" extension	48"	48"	48"	48"	8'	8'
Tube type	Rigid	Rigid	Rigid	Rigid	Flexible	Flexible
Maximum recommended installation length	30'	30'	30'	30'	8'	8'

Dome/Flashing	TGR 014	TMR 014	TLR 014	TCR 014	TMF 014	TGF 014
Flat Glass Shingle/shake roof Code 2000 Delivery S	N/A	N/A	\$633	N/A	N/A	N/A
Acrylic Dome Shingle/shake roof Code 0000 Delivery S	\$443	\$443	N/A	\$504	\$404	\$408
Impact Dome Shingle/shake roof Code 1000 Delivery T	\$468	\$468	N/A	\$529	\$429	\$433

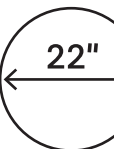

22" Sun Tunnel	TGF 022	TGR 022
Tube length with kit Rigid kits include 2 elbows & 24" extension Subtract approximately 6" for flashing	8'	48"
Tube type	Flexible	Rigid
Maximum recommended installation length	12'	40'

Dome/Flashing	TGF 022	TGR 022
Acrylic Dome Shingle Code 0000 Delivery S	\$548	N/A
Impact Dome Shingle Code 1000 Delivery T	\$582	N/A
Acrylic Dome Shingle - ships in multiple boxes Code S0000 Delivery F	N/A	\$810
Impact Dome Shingle - ships in multiple boxes Code S1000 Delivery F	N/A	\$845

Free light.
Day or night.



Designed to fit inside the rigid tube of a VELUX Sun Tunnel skylight, the **VELUX Solar Night Light** gives off a soft, soothing glow from above when natural light isn't available. The night light's solar panel collects available sunlight, even on cloudy days, to power its rechargeable batteries.

Sun Tunnel accessories on pages 46 and 47.

Order Code Example $\frac{\text{TMR}}{\text{product}} + \frac{\text{010}}{\text{size}} + \frac{\text{0000}}{\text{code}} + \frac{\text{SL}}{\text{light}}$

Sun Tunnel® Skylights

Wildfire & Impact Glass



TZR/TZRL
Wildfire or Impact Glass
Curb-Mount



TZRQ
Wildfire or Impact Glass
Pan-Flashed



Roof Pitch
TZR



Roof Pitch
TZRL / TZRQ

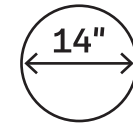

Model	TZR 014	TZRL 014	TZRQ 014
Tube length with kit Rigid kits include 2 elbows & 24" extension	64"	64"	52"
Tube type	Rigid	Rigid	Rigid
Maximum recommended installation length	30'	30'	30'
Flashing	Not included	Step-flashing Included	Pan-flashed

Glass Options	TZR 014	TZRL 014	TZRQ 014
Wildfire Glass Shingle/tile (TZR), shingle (TZRL, TZRQ) Code 2A00 Delivery F	\$536	\$593	\$534
Impact Glass Shingle/tile (TZR), shingle (TZRL, TZRQ) Code 1A00 Delivery T	\$561	\$618	\$559

Flashing	TZR 014	TZRL 014	TZRQ 014
ECW 014Z Curb Mounted Flashing - Shingle/tile Delivery F	\$190	Order TZR ²	N/A
ECL Curb Mounted Flashing - Shingle	Order TZR ¹	Included	N/A

¹ TZRL is a TZR with an ECL flashing kit included. ² Order as a TZR with ECW 014Z.



Diamond Wire
Wildfire Glass

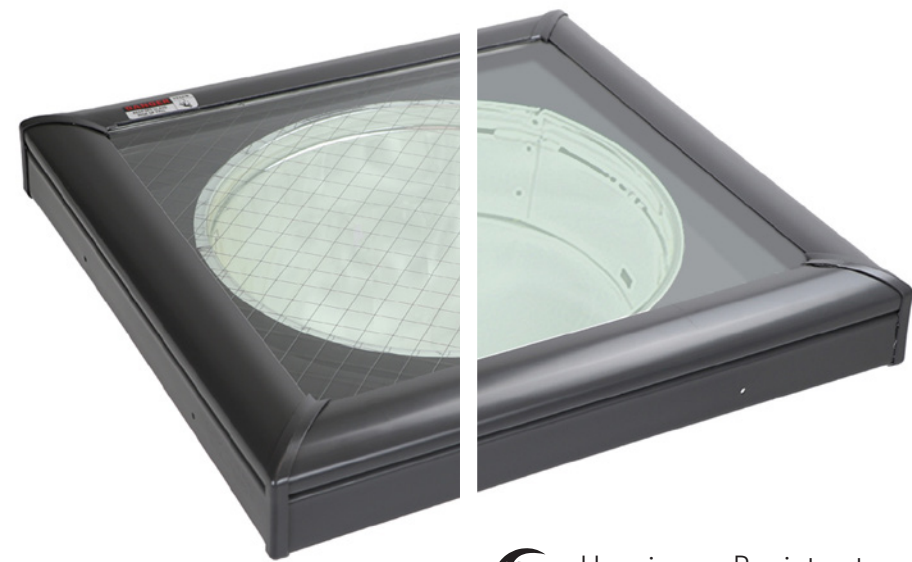

Hurricane Resistant
Impact Glass

Flat Roof Skylights

Curb-Mounted Domed Units

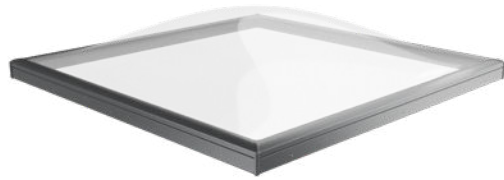

CMD Polycarbonate Double Dome

Custom Sizes 1-800-888-3589
Call for pricing

- 5-year hail warranty.
- Neutral gray exterior color.









CXP Hatch with ISD Polycarbonate Protective Cover

- Opens manually up to 60° for roof access.
- Highly impact resistant domed polycarbonate outer with inner laminated glass pane for added safety, sound control, and thermal protection.
- Insulated PVC frame.







Polycarbonate Double Dome CMD

Standard Sizes (W-in. x H-in.)	2222	2246	3030	3434	4646
					
Outside Curb	25 1/2 x 25 1/2	25 1/2 x 49 1/2	33 1/2 x 33 1/2	37 1/2 x 37 1/2	49 1/2 x 49 1/2
Maximum Skylight Clearance	26 5/8 x 26 5/8	26 5/8 x 50 5/8	34 5/8 x 34 5/8	38 5/8 x 38 5/8	50 5/8 x 50 5/8
Glazing	2222	2246	3030	3434	4646
Clear over clear polycarbonate Code 00CC Delivery F	\$195	\$260	\$246	\$297	\$478

Hatch CXP with Polycarbonate Top Cover ISD

(Both are required)

Standard Sizes (W-in. x H-in.)	090120	100100	120120
			
Rough Opening	35 7/16 x 47 1/4	39 3/8 x 39 3/8	47 1/4 x 47 1/4
Exterior Frame	42 1/2 x 54 5/16	46 7/16 x 46 7/16	54 5/16 x 54 5/16
Top Cover	090120	100100	120120
Polycarbonate ISD Code 0010 Delivery G	\$365	\$331	\$429
Base Unit (Required)	090120	100100	120120
Hatch CXP Code 0473Q Delivery G	\$1,219	\$1,165	\$1,372

Note: Must order both base unit and top cover to make a complete skylight unit. Base and cover will ship and invoice separately.

Flat Roof Skylights

Curb-Mounted CFU/ISU



CFU Fixed Base with ISU CurveTech Protective Top Cover



CFU Fixed Base

- Laminated thermal pane for added safety, sound control, and thermal protection.



ISU CurveTech Protective Top Cover

- CurveTech glass lets rainwater easily roll off for a clean look while preventing leaks.
- Tempered glass is virtually scratch-proof, providing a durable layer of protection.
- Unique curved glass with a modern and innovative design.



Curb-Mounted CFU/ISU

Standard Sizes (W-in. x H-in.)	060060	080080	090060	120090	120120
Rough Opening	23 11/16 x 23 11/16	31 9/16 x 31 9/16	35 1/2 x 23 11/16	47 5/16 x 35 1/2	47 5/16 x 47 5/16
Exterior Frame	32 1/16 x 32 1/16	39 15/16 x 39 15/16	43 7/8 x 32 1/16	55 11/16 x 43 7/8	55 11/16 x 55 11/16
Standard Sizes Continued (W-in. x H-in.)	090090	100100	150100	150150	200100
Rough Opening	35 1/2 x 35 1/2	39 7/16 x 39 7/16	59 1/8 x 39 7/16	59 1/8 x 59 1/8	78 3/4 x 39 7/16
Exterior Frame	43 7/8 x 43 7/8	47 13/16 x 47 13/16	67 1/2 x 47 13/16	67 1/2 x 67 1/2	87 3/16 x 47 13/16

CFU Fixed Base Unit

ISU Top Cover required when purchasing CFU fixed base unit

Standard Sizes	060060	080080	090060	120090	120120
Code 0020Q Delivery G	\$378	\$469	\$444	\$620	\$688
Standard Sizes	090090	100100	150100	150150	200100
Code 0020Q Delivery N	\$582	\$620	\$698	\$1,094	\$1,159

ISU Top Cover

Standard Sizes	060060	080080	090060	120090	120120
Code 1093 Delivery G	\$484	\$535	\$515	\$687	\$748
Standard Sizes	090090	100100	150100	150150	200100
Code 1093 Delivery N	\$578	\$641	\$779	\$1,154	\$1,147

Note: Must order both base unit and top cover to make a complete skylight unit. Base and cover will ship and invoice separately.

Skylight Flashing

Deck-Mounted Combi-Flashing™



EKL

low-profile roofing material
shingles/shakes

EKW

high-profile roofing material
tile/corrugated metal



EKL/EKW Roof Pitch

14° - 85°
3:12 - 137:12

- Combi-Flashing™ allows for large installations of multiple skylights.
- Must specify vertical gutter spacing when ordering. May be from 2.5" to 12" in 1/2" increments. Combi-Flashings™ with gutters 4.5" or wider have additional charges.
- Only the 2 1/2", 3", 3 1/2" and 4" gutters are stocked; all other widths are special order and carry a 15-day production time.
- 1 x (over/under) combinations have 4" horizontal gutter only.
- EKW has 4" gutter side by side configuration only.
- Gutter sizes listed are frame to frame – RO to RO will be 1/2" larger, ex. 3" listed gutter = 3 1/2" RO to RO.



HGTW
URBAN OASIS
PROUD SPONSOR
— 2022 —

Sizes		C01	C04	C06	C08	C12	M02	M04	M06	M08	S01	S06
1 by 2 Flashing Configuration												
<input type="checkbox"/> <input type="checkbox"/>	EKL Low-Profile Delivery T	\$330	\$330	\$330	\$360	\$360	\$360	\$360	\$360	\$360	\$407	\$407
1 by 3 Flashing Configuration												
<input type="checkbox"/> <input type="checkbox"/> <input type="checkbox"/>	EKL Low-Profile Delivery T	\$545	\$545	\$545	\$575	\$575	\$594	\$594	\$594	\$594	\$676	\$676
2 by 1 Flashing Configuration												
<input type="checkbox"/> <input type="checkbox"/>	EKL Low-Profile Delivery T	\$338	\$338	\$338	\$408	\$408	\$362	\$362	\$362	\$362	\$404	\$404
	EKW High-Profile Delivery T	Call	Call	Call	N/A	N/A	Call	Call	Call	Call	Call	Call
2 by 2 Flashing Configuration												
<input type="checkbox"/> <input type="checkbox"/> <input type="checkbox"/> <input type="checkbox"/>	EKL Low-Profile Delivery T	\$802	\$802	\$802	\$872	\$872	\$860	\$860	\$860	\$860	\$966	\$966
2 by 3 Flashing Configuration												
<input type="checkbox"/> <input type="checkbox"/> <input type="checkbox"/> <input type="checkbox"/> <input type="checkbox"/>	EKL Low-Profile Delivery T	\$1,266	\$1,266	\$1,266	\$1,336	\$1,336	\$1,358	\$1,358	\$1,358	\$1,358	\$1,528	\$1,528
3 by 1 Flashing Configuration												
<input type="checkbox"/> <input type="checkbox"/> <input type="checkbox"/>	EKL Low-Profile Delivery T	\$523	\$523	\$523	\$593	\$593	\$557	\$557	\$557	\$557	\$617	\$617
	EKW High-Profile Delivery T	Call	Call	Call	N/A	N/A	Call	Call	Call	Call	Call	Call
3 by 2 Flashing Configuration												
<input type="checkbox"/> <input type="checkbox"/> <input type="checkbox"/> <input type="checkbox"/> <input type="checkbox"/> <input type="checkbox"/>	EKL Low-Profile Delivery T	\$1,205	\$1,205	\$1,205	\$1,275	\$1,275	\$1,286	\$1,286	\$1,286	\$1,286	\$1,434	\$1,434
4 by 1 Flashing Configuration												
<input type="checkbox"/> <input type="checkbox"/> <input type="checkbox"/> <input type="checkbox"/> <input type="checkbox"/> <input type="checkbox"/>	EKL Low-Profile Delivery T	\$708	\$708	\$708	\$778	\$778	\$752	\$752	\$752	\$752	\$830	\$830
	EKW High-Profile Delivery T	Call	Call	Call	N/A	N/A	Call	Call	Call	Call	Call	Call

Many other combinations can be made beyond what is listed in the pricing chart. Call customer service for more combi-flashing™ options and pricing. Measurement must be taken from rough opening to rough opening.

Large orders may require longer lead times. Combi-flashings™ are not available for models FCM, VCM, VCE, QPF, or VCS. VSS is not available in 1 by 3 or 2 by 3 configurations due to the solar panel.

Skylight Accessories

Skylight & Roof Window Shades



Room-Darkening
Double-Pleated

Standard with VELUX
Skylight System models

Unique honeycomb structure adds an extra layer of fabric to block bright sunlight.



Light-Filtering
Single-Pleated

The single-pleated shades softly diffuse natural light, helping prevent glare.

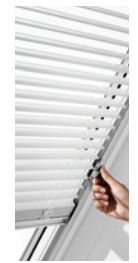

Venetian

Available for roof windows only

Lightweight, horizontal slats provide style and easy light control for any room.

Model and size code on your skylight:



Model Size

Order code example:

FSCD	C06	1045KWL
shade model	+ skylight size	+ color code



HGTV
URBAN OASIS
PROUD SPONSOR
2024

Solar-Powered Skylight Shades

For custom sizes, colors, and/or shade type see Special Order pricing below.

In-Stock Skylight Shade¹

Room-Darkening, Double-Pleated

Skylight Model	Code	Price
VSS/VSE	FSCD	\$450
VS	FSCD	\$450
FS	FSCD	\$450
VCS/VCE/VCM/QPF	FSCC	\$450
FCM	FSCC	\$490*

1045
White

* FCM price includes accessory tray.

Special Order Skylight Shade Options²

Room-Darkening, Double-Pleated

1155 Beige	1163 Grey	1164 Grey Melange	1171 Dark Sand	1172 Light Grey
1047 Charcoal	1049 Golden Beige	1156 Blue	1165 Light Brown	1173 Petrol
1168 Dusty Green	1169 Light Blue	1170 Dark Taupe	1166 Ivory	1167 Orange

Light Filtering, Single-Pleated

1016 White	1259 Classic Sand	1275 Natural	1282 Dark Grey	1286 Jeans Blue
1256 Classic White	1274 Charcoal	1276 Dusty Brown	1277 Dusty Sand	1278 Beige
1280 Forest Green	1281 Mint Green	1283 Light Beige	1284 Grey	1285 Soft Blue
1279 Red Wine				

Skylight Model	Code - Room Darkening	Code - Light Filtering	Price
VSS/VSE	FSCD	FSLH	\$525
VS	FSCD	FSLH	\$525
FS	FSCD	FSLD	\$525
VCS/VCE/VCM/QPF	FSCC	FSLC	\$525
FCM	FSCC	FSLC	\$675*

* FCM = shade price + accessory tray

Manual Roof Window Shades

Ships separately from Roof Window

In-Stock Roof Window Shade Options¹

Room Darkening, Double Pleated

Roof Window Model	Code	Price
GPU/GXU/GGU	FHC	\$250
GDL ⁶	FHC	\$500

1045
White

Light Filtering, Single Pleated

Roof Window Model	Code	Price
GPU/GXU/GGU	FHL	\$250
GDL ³	FHL	\$500

1016
White

Venetian

Roof Window Model	Code	Price
GPU/GXU/GGU	PAL	\$250
GDL ³	PAL	\$500

7001
White

Slats measure 1.375"

Special Order Roof Window Shade Options²

Room-Darkening, Double-Pleated

1155 Beige	1163 Grey	1164 Grey Melange	1171 Dark Sand	1172 Light Grey
1047 Charcoal	1049 Golden Beige	1156 Blue	1165 Light Brown	1173 Petrol
1168 Dusty Green	1169 Light Blue	1170 Dark Taupe	1166 Ivory	1167 Orange

Light Filtering, Single-Pleated

1256 Classic White	1259 Classic Sand	1275 Natural	1282 Dark Grey	1286 Jeans Blue
1274 Charcoal	1276 Dusty Brown	1277 Dusty Sand	1278 Beige	1280 Forest Green
1281 Mint Green	1283 Light Beige	1284 Grey	1285 Soft Blue	1279 Red Wine

Roof Window Model	Code - Room Darkening	Code - Light Filtering	Price
GPU/GXU/GGU	FHC	FHL	\$325
GDL ³	FHC	FHL	\$650

¹ In-Stock: Solar skylight shades are sold separately (2-4 business days) and/or factory installed as a part of VELUX Skylight Systems. Custom sizes are sold separately as special order. Manual roof window shades not eligible for factory installation. ² Special Order: No factory installation for special order skylight or roof window shades. Shades ship separately: skylights 14 business days and roof windows up to 8 weeks. ³ GDL requires two shades, one each for top and bottom windows

Skylight Accessories

Home Automation

VELUX ACTIVE

Includes Climate Sensor, Departure Switch, and Internet Gateway

Model	Price	Delivery
KIX 300 US	\$306	S



VELUX App Control

Automated scheduling and smart device control of your VELUX shades.

Model	Price	Delivery
KIG 300 US	\$161	S



VELUX ACTIVE Indoor Climate Sensor

Additional sensor for other rooms with VELUX skylights

Model	Price	Delivery
KLA 300 US	\$133	S



Home Automation Integration Kit

Wirelessly control up to five groups of solar/electric-powered skylights or shades

Model	Price	Delivery
KLF 200 US	\$291	S



VELUX ACTIVE Departure Switch

Additional departure switch

Model	Price	Delivery
KLN 300 US	\$67	S



Installation Accessories

Additional Step Flashing Deck/Curb

Deck-mounted = 14 pieces - ZZZ 200 0000
Curb-mounted = 12 pieces - ZZZ 200 0000C

Model	Price	Delivery
ZZZ 200 0000	\$27	S
ZZZ 200 0000C	\$30	S

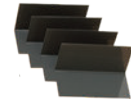

Trim Groove Filler Kit

Three 57 1/2" pieces. One kit will work for most sizes

Model	Price	Delivery
ZZZ 213B	\$51	S



Adhesive Underlayment

9" x 26' per roll

Model	Price	Delivery
ZOZ 216L	\$52	S

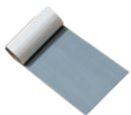

Replacement Kit

4 pre-cut drywall groove filler pieces and 4 structural brackets. Use in deck-mounted applications Sizes: C01, C04, C06, C08, D06, D26, M02, M04, M06, M08, S01, S06

Model	Price	Delivery
ZZZ 238 + size	\$72	S

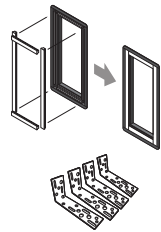

Structural Brackets 4 brackets

Use in deck-mounted applications with an oversized rough opening

Model	Price	Delivery
ZZZ 219	\$29	T



Shade Accessory Tray

Needed for shade installation on Fixed Curb-Mounted Skylights (2222-4646)

Model	Price	Delivery
ZZZ 199 + size	\$156	S



Also for EF skylights, excluding sizes 2239, 2254, 3054

Sun Screen Adapter Kit

Allows skylight models manufactured prior to January 1, 2010 to have special order shades. V-venting, F-fixed

Model	Price	Delivery
ZZZ 232V	\$49	T
ZZZ 232F	\$49	T

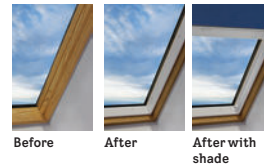

Wildfire Screen

Made to meet California's strictest fire codes for new skylight installations, these screens are compatible with all our Deck-Mounted and Curb-Mounted skylights.

Model	Price	Delivery
ZZZ 256 + size	\$44 - \$93	F



Remotes & Electric

Basic Remote Control

Remote control allows users to operate single skylight or shade from anywhere in the room

Model	Price	Delivery
KLI 310 US	\$128	S



VELUX Touch Remote Control

Remote control allows users to operate multiple skylights and shades with one remote from anywhere in the room, not dependent on Wi-Fi

Model	Price	Delivery
KLR 300 WW	\$161	S



Manual Controls

VS/VCM Crank Handle

Operate in-reach manual venting skylight

Model	Price	Delivery
ZZZ 201 (VS)	\$14	S
ZZZ 212 (VCM)*	\$35	S

*Includes the ZZZ 208 extension.



VS/VCM Replacement Hook

Replacement hook for out-of-reach manual venting skylight

Model	Price	Delivery
ZZZ 202 (VS)	\$14	S
ZZZ 211 (VCM)	\$14	S



Extension Chain Operator

Extension for manual crank handle or manual angle adaptor to make skylights easier to operate

Model	Price	Delivery
ZZZ 208	\$28	S



Angle Adaptor for Chain Operator

Used in conjunction with the manual hook for out-of-reach applications to make the skylight easier to operate with a manual pole

Model	Price	Delivery
ZZZ 203	\$45	S



Battery Backup

Provides limited operation of one VSE or VCE skylight during power outages

Model	Price	Delivery
KLB 100 WW	\$384	S



Telescopic Rod 6'-10' Manual Skylights

For VS and VCM skylights from 1982 to present and sun screen accessories made prior to 2010

Model	Price	Delivery
ZCT 300	\$60	S



Telescopic Rod 3'-6' Manual Shades

For operation of manual sunscreen accessories

Model	Price	Delivery
ZXT 200	\$47	S



Universal Extension 3'

Extension piece for telescopic rods. Extends control rods for an additional 3'

Model	Price	Delivery
ZCT 100	\$21	S



Sun Tunnel® Skylight Accessories

Lighting

Solar Night Light

Provides low level light available for rigid tube only

Model	Price	Delivery
ZTZ 213	\$39	S



Daylight Controller

Motorized variable positioning daylight control device. Requires ZZZ 233 Power Supply

Model	10"	14"	Delivery
ZTP	N/A	\$329	F



Power Supply

Power supply for control devices

Model	Price	Delivery
ZZZ 233	\$182	F



Universal Electric Light Kit

Designed to let Sun Tunnel® be a source of light at night and during the day

Model	10"	14"	22"	Delivery
ZTL 114	\$66	\$66	N/A	S
ZTL 122	N/A	N/A	\$74	S



Discontinued – While Supplies Last

Diffusion Enhancer - 6" band

Highly reflective obscure 6" band designed to diffuse direct sunlight

Model	10"	22"	Delivery
ZTZ 209	\$70	\$75	S



Tube

Rotation Coupler

Enables quick elbow connections when getting around obstacles in the attic is required

Model	10"	14"	Delivery
ZTZ 211	\$50	\$55	S



Elbows

Can be used at bottom, middle, or top of your installation - can form a 90 degree bend using multiple elbows with rotating couplers

Model	10"	14"	22"	Delivery
ZTE 0000	\$63	\$88	\$135	S



Rigid Tube 24" reflective tube sections

Available in bulk quantities

Model	10"	14"	22"	Delivery
ZTR 2' - 1 unit	\$50	\$71	\$105	S
ZTR 4' - 2 units	\$98	\$135	\$198	S
ZTR 6' - 3 units	\$131	\$179	\$266	S
ZTR 12' - 6 units	\$232	\$324	\$400	S
ZTR 24' - 12 units	\$414	\$588	\$758	S



Suspension Wire Kit

12-gauge wire and fastener set to secure longer tube sections

Model	Price	Delivery
ZTZ 203	\$31	F



Performance Enhancing

Energy Kit

Designed to increase energy efficiency; includes a thermal plate and a diffusing disc

Model	10"	14"	22"	Delivery
ZTC 0051US	\$51	\$64	N/A	S
ZTC 0041US	N/A	N/A	\$80	S



Exterior Fire Band

Designed to meet fire prevention requirements of building codes - not available for TSR 10"

Model	10"	14"	22"	Delivery
ZZZ 192	\$99	\$108	\$118	F



Vapor Barrier

Designed for protecting flashing components and ceiling opening from condensation

Model	10"	14"	22"	Delivery
ZTY	\$63	\$63	\$63	T



Decorative Diffusers

Simple way to enhance your ceiling and ensure that your diffuser film matches the décor and feel of the room

Model	Description	10"	14"	Delivery
ZTB 4004US	Micro Fresnel	\$22	\$36	S
ZTB 4005US	Triple Wave	\$22	\$36	S
ZTB 4006US	Brushed Metal	\$22	\$36	S
ZTB 4007US	Prismatic	\$22	\$36	S
ZTB 4009US	Neutral light	\$22	\$36	S



Flashing

Curb-Mounted Flashing - Tile

Install on tile roofing material over 3/4" thickness for roof pitch 14-60° for TCR and TZR models

Sun Tunnel	Flashing Model	14"	Delivery
TCR	ECW 014 0000	\$232	S
TZR	ECW 014Z 0000	\$190	F



Sun Tunnel® Flashing - Tile

Water-tight flashing without the use of sealants Only for TMR and TMF

Model	10"	14"	Delivery
ZTM 0000 50	\$183	\$200	F



Roof Windows

Top-Hinged GPU



45° GPU Top-hinged Roof Window

GPU Roof Pitch
15° - 55°
3:12 - 17:12

- Designed for in-reach applications, such as bonus rooms or attics.
- **Stocked GPU Units are for Roofs with a Maximum of 55° Roof Pitch.** Roofs with a pitch greater than 55° need to order GPU units with special springs for an additional \$100 per unit.

Opens to a maximum of 45° to satisfy egress requirements for emergency escape.
(MK06, MK08, PK10, SK06, UK08 meet egress requirements. CK04, CK06, MK04 do not meet egress requirements.)
Check your local codes for compliance.

Add a Manual Shade: White, Room-Darkening, Double-Pleated
See accessories on the next page. For more shade color options, see special order shade options on page 43.



Standard Sizes (W-in. x H-in.)	CK04	CK06	MK04	MK06	MK08	PK10	SK06	UK08
Outside Frame	21 5/8 x 38 1/2	21 5/8 x 46 3/8	30 3/4 x 38 1/2	30 3/4 x 46 3/8	30 3/4 x 55	37 1/8 x 63	44 7/8 x 46 3/8	52 3/4 x 55 1/16
Rough Opening	22 1/8 x 39	22 1/8 x 46 7/8	31 1/4 x 39	31 1/4 x 46 7/8	31 1/4 x 55 1/2	37 5/8 x 63 1/2	45 3/8 x 46 7/8	53 1/4 x 55 1/2

Base Model	CK04	CK06	MK04	MK06	MK08	PK10	SK06	UK08
Laminated Glass Code 0070 Delivery T	\$1013	\$1,080	\$1,071	\$1,149	\$1,232	\$1,547	\$1,377	\$1,711

Flashing	CK04	CK06	MK04	MK06	MK08	PK10	SK06	UK08
Step Flashing Asphalt Shingles, Wood Shakes, or Slate Up to 1/2 inch maximum thickness Code EDL Delivery T	\$124	\$124	\$146	\$146	\$146	\$174	\$183	\$198
High Profile Flashing Tile - Over 3/4 inch thickness Code EDW Delivery T	\$207	\$207	\$244	\$244	\$244	\$290	\$305	\$329

All cladding components for roof windows are included in the flashing box. If VELUX flashing is not used, then ZWC cladding pieces must be ordered. Call Customer Service for pricing on Flashing Kits available for when replacing old Roof Windows with new Roof Windows.

Accessories	CK04	CK06	MK04	MK06	MK08	PK10	SK06	UK08
Manual Shade White, Room-Darkening, Double-Pleated Code FHC 1045SWL Delivery T					\$250			
Manual Shade White, Light-Filtering, Single-Pleated Code FHL 1016SWL Delivery T					\$250			
Manual Shade White Venetian Code PAL 7001SWL Delivery T					\$250			
Insect Screen Code ZIL 0000SWL Delivery T					\$144			

Roof Windows

Roof Access GXU



GXU Roof Access
Roof Window



GXU Roof Pitch

- Opens 90° for easy access to the outdoors.
- Designed for in-reach applications.



FK06 satisfies egress requirements for emergency escape.
(CK06 size does not meet requirements for emergency escape.)

Check your local codes for compliance.



Add a Manual Shade: White, Room-Darkening, Double-Pleated

See accessories on the next page. For more shade color options, see special order shade options on page 43.



Standard Sizes (W-in. x H-in.)	CK06	FK06
Outside Frame	21 5/8 x 46 3/8	26 x 46 3/8
Rough Opening	22 1/8 x 46 7/8	26 1/2 x 46 7/8

Base Model	CK06	FK06
Laminated Glass Code 0070 Delivery T	\$1,134	\$1,167

Flashing	CK06	FK06
Step Flashing Asphalt Shingles, Wood Shakes, or Slate Up to 1/2 inch maximum thickness Code EDL Delivery T	\$124	\$139
High Profile Flashing Tile - Over 3/4 inch thickness Code EDW Delivery T	\$207	\$232

All cladding components for roof windows are included in the flashing box. If VELUX flashing is not used, then ZWC cladding pieces must be ordered.

Accessories	CK06	FK06
Manual Shade White, Room-Darkening, Double-Pleated Code FHC 1045SWL Delivery T	\$250	\$250
Manual Shade White, Light-Filtering, Single-Pleated Code FHL 1016SWL Delivery T	\$250	\$250
Manual Shade White Venetian Code PAL 7001SWL Delivery T	\$250	\$250
Insect Screen Code ZIL 0000SWL Delivery T	\$144	\$144

Roof Windows

Balcony GDL



GDL Balcony Roof Window



GDL Balcony Roof Pitch

- Dual-sash operation: top opens for ventilation and bottom opens outward to create a roof balcony.
- When the GDL Balcony Roof Window is closed, a ventilation flap can be opened to provide a breath of fresh air, even if it is raining outside.
- For in-reach application only.



Add Manual Shades: White, Room-Darkening, Double-Pleated

See accessories on the next page. For more shade color options, see special order shade options on page 43.



GDL can meet emergency escape egress requirements. Check your local codes for compliance.



Standard Sizes	MK19	PK19
(W-in. x H-in.)		
Outside Frame	30 3/4 x 99 1/4	37 1/16 x 99 1/4
Rough Opening	33 1/16 x 101	39 3/8 x 101

Base Model	MK19	PK19
Laminated Glass/Aluminum Code 3066 Delivery T	\$3,603	\$5,674

Flashing	MK19	PK19
Step Flashing Asphalt Shingles, Wood Shakes, or Slate Up to 1/2 inch maximum thickness Code EDL Delivery T	\$151	\$174
High Profile Flashing Tile - Over 3/4 inch thickness Code EDW Delivery T	\$251	\$290

Accessories	MK19	PK19
Manual Shade ¹ White, Room-Darkening, Double-Pleated Code FHC SD1045SWL Delivery T	\$500	\$500
Manual Shade ¹ White, Light-Filtering, Single-Pleated Code FHL SD1016SWL Delivery T	\$500	\$500
Insect Screen Insect Screen, Black Mesh Code ZIL SD0000SWL Delivery T	\$340	\$340

¹ Shade price includes two shades, one each for top and bottom windows.

Roof Windows

Center-Pivot GGU



GGU Center-Pivot
Roof Window



GGU Roof Pitch

- Easy to open and quick to close with the top control bar.
- For in-reach application only.



Add a Manual Shade: White, Room-Darkening, Double-Pleated

See accessories on the next page. For more shade color options, see special order shade options on page 43.



Standard Sizes	CK02	CK04	CK06	FK04	FK06	FK08	MK04	MK06	MK08	MK10	PK06	PK08	PK10	SK06	SK08	UK04	UK08
(W-in. x H-in.)																	

Outside Frame	21 ⁵ / ₈ x 30 ⁵ / ₈	21 ⁵ / ₈ x 38 ¹ / ₂	21 ⁵ / ₈ x 46 ³ / ₈	26x 38 ¹ / ₂	26x 46 ³ / ₈	26x 55	30 ³ / ₄ x 38 ¹ / ₂	30 ³ / ₄ x 46 ³ / ₈	30 ³ / ₄ x 55	30 ³ / ₄ x 63	37 ¹ / ₈ x 46 ³ / ₈	37 ¹ / ₈ x 55	37 ¹ / ₈ x 63	44 ⁷ / ₈ x 46 ³ / ₈	44 ⁷ / ₈ x 55	52 ³ / ₄ x 38 ¹ / ₂	52 ³ / ₄ x 55 ¹ / ₁₆
Rough Opening	22 ¹ / ₈ x 31 ¹ / ₈	22 ¹ / ₈ x 39	22 ¹ / ₈ x 46 ⁷ / ₈	26 ¹ / ₂ x 39	26 ¹ / ₂ x 46 ⁷ / ₈	26 ¹ / ₂ x 55 ¹ / ₂	31 ¹ / ₄ x 39	31 ¹ / ₄ x 46 ⁷ / ₈	31 ¹ / ₄ x 55 ¹ / ₂	31 ¹ / ₄ x 63 ¹ / ₂	37 ⁵ / ₈ x 46 ⁷ / ₈	37 ⁵ / ₈ x 55 ¹ / ₂	37 ⁵ / ₈ x 63 ¹ / ₂	45 ³ / ₈ x 46 ⁷ / ₈	45 ³ / ₈ x 55 ¹ / ₂	53 ¹ / ₄ x 39	53 ¹ / ₄ x 55 ¹ / ₂

Base Model	CK02	CK04	CK06	FK04	FK06	FK08	MK04	MK06	MK08	MK10	PK06	PK08	PK10	SK06	SK08	UK04	UK08
Laminated Glass Code 0070 Delivery N	\$690	\$739	\$789	\$789	\$846	\$903	\$782	\$839	\$899	\$952	\$945	\$1030	\$1,130	\$1,005	\$1,144	\$1,130	\$1,249

Flashing	CK02	CK04	CK06	FK04	FK06	FK08	MK04	MK06	MK08	MK10	PK06	PK08	PK10	SK06	SK08	UK04	UK08
Step Flashing Code EDL Delivery T	\$124	\$124	\$124	\$139	\$139	\$139	\$146	\$146	\$146	\$146	\$174	\$174	\$174	\$183	\$183	\$198	\$198
High Profile Flashing Code EDW Delivery T	\$207	\$207	\$207	\$232	\$232	\$232	\$244	\$244	\$244	\$244	\$290	\$290	\$290	\$305	\$305	\$329	\$329

All cladding components for roof windows are included in the flashing box. If VELUX flashing is not used, then ZWC cladding pieces must be ordered. Call Customer Service for pricing on Flashing Kits available for when replacing old Roof Windows with new Roof Windows.

Accessories	CK02	CK04	CK06	FK04	FK06	FK08	MK04	MK06	MK08	MK10	PK06	PK08	PK10	SK06	SK08	UK04	UK08
Manual Shade White, Room Darkening, Double-Pleated Code FHC 1045SWL Delivery T	\$250N	\$250	\$250	\$250N	\$250	\$250	\$250N	\$250	\$250	\$250	\$250N	\$250N	\$250	\$250	\$250N	\$250	\$250
Manual Shade White, Light-Filtering, Single-Pleated Code FHL 1016SWL Delivery T	\$250N	\$250	\$250	\$250N	\$250	\$250	\$250N	\$250	\$250	\$250N	\$250N	\$250	\$250	\$250	\$250N	\$250	\$250
Manual Shade White Venetian Code PAL 7001SWL Delivery T	\$250	\$250	\$250	\$250	\$250	\$250	\$250	\$250	\$250	\$250	\$250	\$250	\$250	\$250	\$250	\$250	\$250
Insect Screen Code ZIL 0000SWL Delivery T	\$144	\$144	\$144	\$144N	\$144	\$144	\$144N	\$144	\$144	\$144N	\$144N	\$144N	\$144	\$144	\$144N	\$144	\$144

Architectural Skylights

Custom Skylight Systems



- Unlimited design capabilities to create spectacular daylighting applications.
- Capable of spanning up to 40 feet.
- Broad range of glass options to select from, including hurricane-rated, electrochromic, photovoltaic, and insulated glass, or cellular polycarbonate with option for aerogel fill.
- Available in standard or custom sizes, both with reliable engineering, construction, and installation.
- Choose from a broad range of interior and exterior finishes.

Custom Finish Colors:

Gloss powder coat finish formulated with durable polyester resins and solar-reflective pigments.

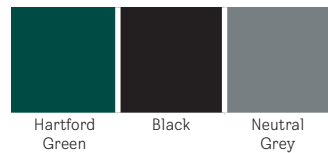

Anodized metal appearance, ultra-matte smooth powder coat finish.

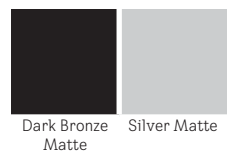

Mill finish standard. Other custom finish options and colors are available. Visit commercial.veluxusa.com/products/finishes for full list of finish options.



Pinnacle System

- Spans up to 40' wide, unlimited length
- Self-supporting structural system
- Custom skylight pitches 15° - 60°
- Flat or pitched roof applications
- Custom glazing options
- Custom finish colors
- Site-built system



Square Pyramid



Polygonal Pyramid



Extended Pyramid

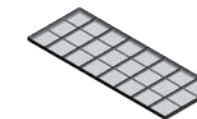

Single Pitch

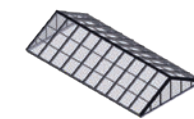

Double Pitch

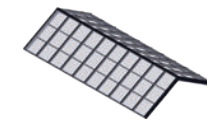

Structural Ridge

Classic System

- Spans up to 6' wide, unlimited length
- Self-supporting structural system
- Three standard skylight pitches: 5:12, 7:12, 12:12
- Flat or pitched roof applications
- Custom glazing options
- Custom finish colors
- Factory welded and assembled



Square Pyramid

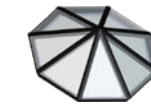

Polygonal Pyramid



Extended Pyramid



Double Pitch

Low Profile System

- Unlimited width and length
- Structural support required
- Pitched roof applications
- Custom glazing options
- Custom finish colors
- Factory-built or site-built system

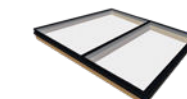

Low Profile

Architectural Skylights

VELUX Modular Skylights – VMS



VMS Roof Pitch

- Pre-glazed module with 100% prefabricated components and unique bracket system guarantees a predictable installation process
- Watertight design ensures moisture protection without need for sealants
- Hidden chain actuators allow modules to vent allowing fresh air into the building
- Internal shades can be pre-installed allowing for shading throughout the day
- Velux Modular Skylight systems available for roof pitches between 0°-90°
- VMS electronic control systems offer heavy wind and rain sensor controls
- Email commercialestimating.us@velux.com for details

The installer is responsible for curb-flashing material and installation of the curb to the roof.



The unique bracket system that makes every module fit every solution

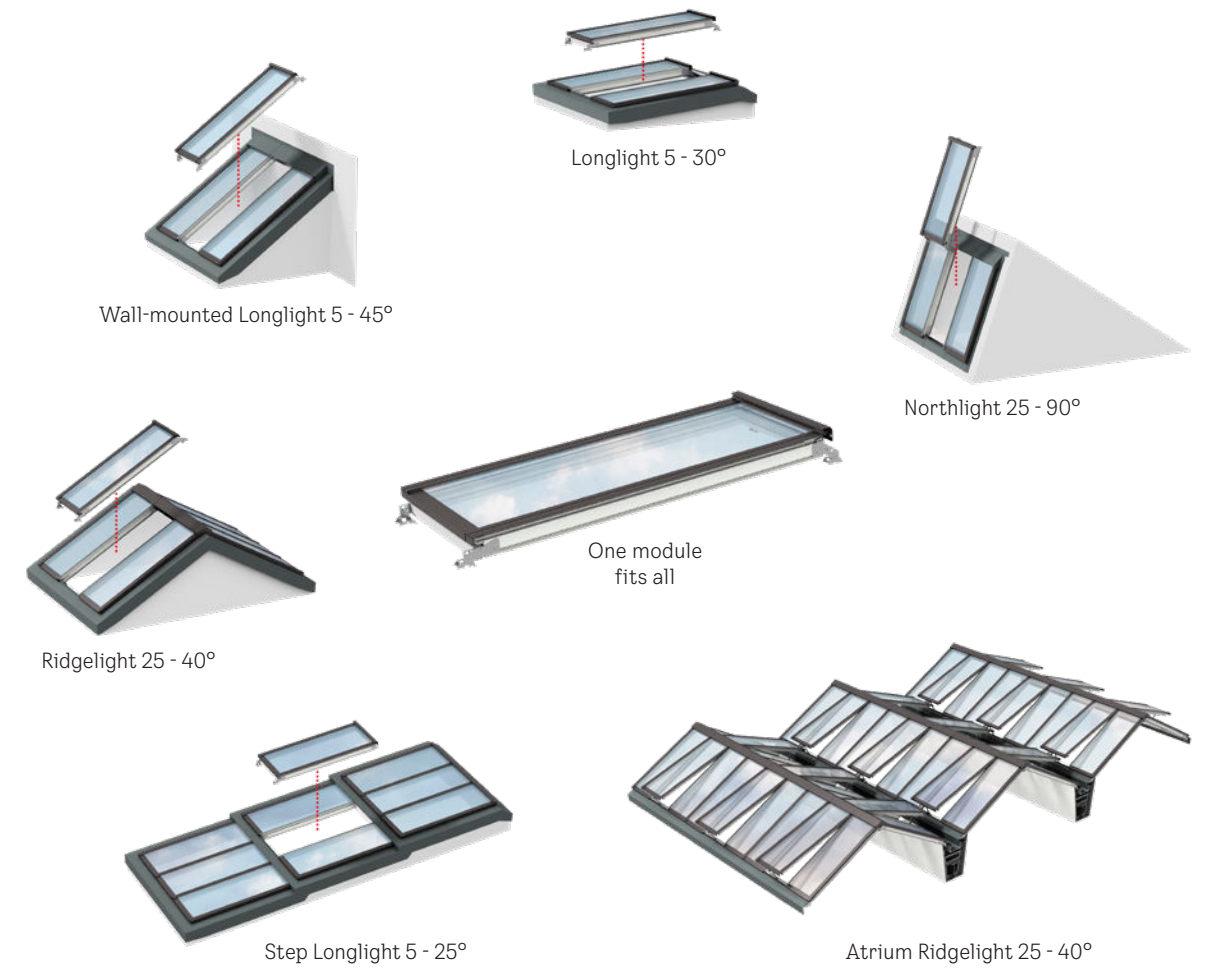

VMS modules can be equipped with electrically-operated roller shades

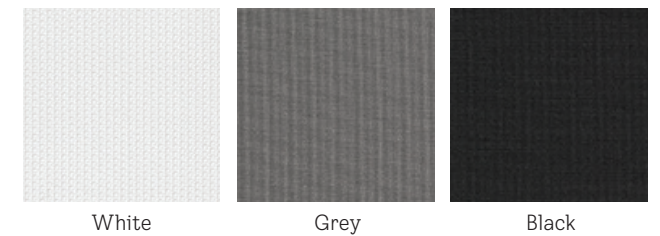

Delivery time approximately 10-12 weeks for product and shades.

Transforming spaces since 1941. For over 80 years, VELUX has helped people envision and achieve the transformation of spaces using daylight and fresh air through the roof. Our product program includes skylights, Sun Tunnel® skylights, decorative shades and roof windows, as well as installation and smart home solutions. By creating brighter, healthier, more sustainable places to live, work, learn, and play we enable a better everyday life for people around the world. We work globally with sales and manufacturing operations in more than 40 countries and around 11,500 employees worldwide. The VELUX Group is owned by VKR Holding A/S, a limited company wholly owned by non-profit, charitable foundations (THE VELUX FOUNDATIONS) and family.

For more information, visit veluxusa.com.



VELUX America LLC
215 Puckett Ferry Road
PO Box 5001
Greenwood, SC 29648-5001

1-800-888-3589

veluxusa.com